

MONOTYPE CATALOG & SPECIMEN BOOK

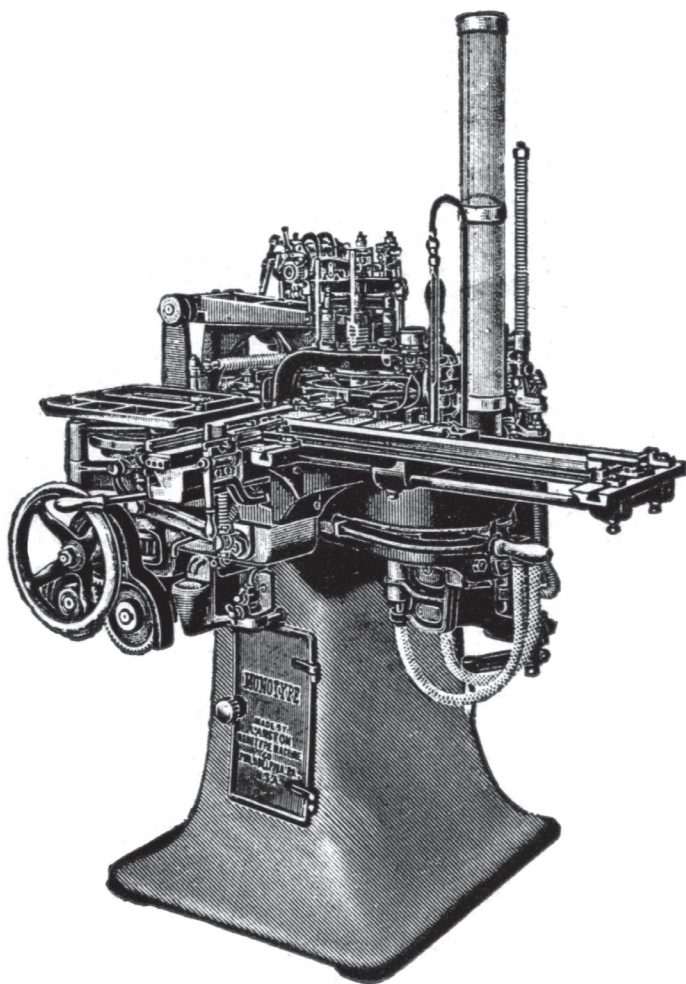

SWAMP PRESS MMXXIII

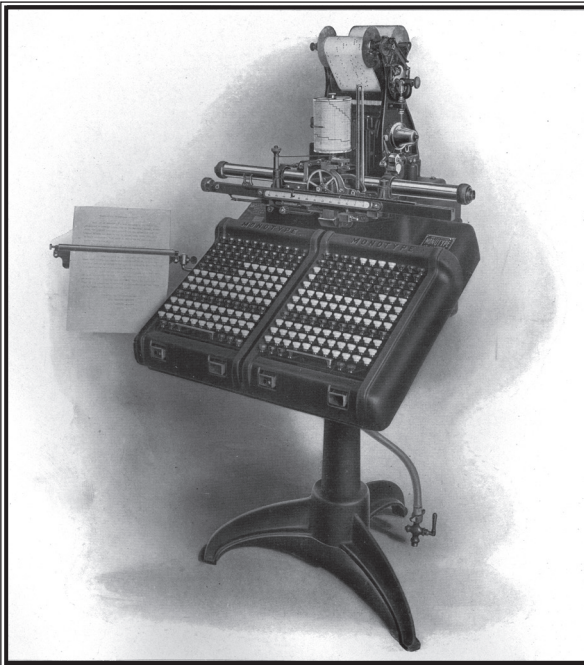

The Monotype Keyboard, which punches a paper ribbon that governs the caster so that a text may be cast to your specifications, and ready for the press.

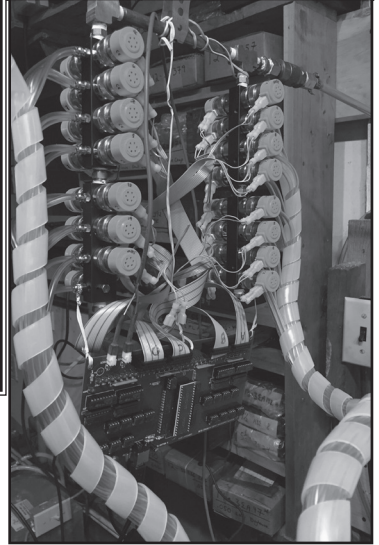
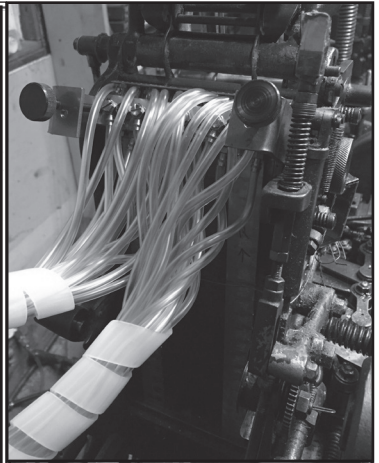

The *Welliver* is a Mac-driven digital interface that now runs the composition caster. Your text file is prepared digitally then the Mac hooked up to a circuit board runs valves regulating the air used to control the caster via the “spaghetti” you see above right, top. Below right are the solenoid valves & the circuit board below them.

Swamp Press

15 Warwick Road • Northfield, MA • 01360

ed@SwampPress.com • 413-345-0427 (cell)

© 2023 by Swamp Press

Swamp Press Type Catalog and Specimen Book

• NOTE • *No catalog is ever complete.* If you do not see what you want, INQUIRE. Sometimes I can borrow matrices for sizes and faces not listed here. • The specimens SOMETIMES show characters which are NOT AVAILABLE. If you have specific requirements, let me know. • If you are MIXING new type into your drawers *send me a cap H* so that my type will align with yours. • “COMPOSITION” means machine typesetting can be done to your specifications. Your manuscript can be set with spacing, justification etc. & ready for the press. When done with your project, you may return the metal for a REFUND of the metal charge or you may *keep some or all of the type* to put into cases for future hand setting. • We now have the WELLIVER digital system for driving the caster, thus eliminating the keyboard. DISPLAY means that one character is cast until it is done and then a new character is cast, and so on, allowing only fonts, sorts and hand composition to be available. IN GENERAL machine composition runs 6 to 12 point although some faces have comp up to 24 point. Many of the classic and newer designs run “small comp” to 14 point and “large comp” to 24 point. But in general 14 to 72 point is hand comp. • Full page SPECIMEN SHEETS, showing particular faces in their many sizes and variations are available in pdf or printed versions. • Separate catalogs of our vast holding of ORNAMENTS and SIGNS are available.

Ed Rayher

This book is divided into four sections:

- I. Serif
- II. Sans Serif & Scripts
- III. Gothics
- IV. Unique & Foreign Faces

End Matter: Font Schemes & Misc. Info

Faces are shown in alphabetical order within each section.

INDEX

- Admiral (Ludlow)—§ Sans & Scripts
Adonis (Intertype) — § Sans & Scripts
Alternate Gothic #51— § Gothics
Alternate Gothic #77— § Gothics
American Garamond #648 see Garamond
American Caslon #637 — see Caslon
Antique, Bold #144
Antique, Bold Condensed #145
Antique, Modern #26
Antique, Modern Cond. #76
Antique Old Style (English) #161
Antique Open — See Beton Open
Arrighi #252, English see Centaur
Artcraft (Ludlow)
Aster (Russian (Linotype)) § Foreign
Baker— unique font by Russell Maret
Baskerville (English) #169
Baskerville #353 Baskerville Bold #453
Bell (English) #341
Bembo (English) #270
Bembo #405
Bembo Bold (English) #428
Ben Franklin Initials #127
Bernhard Fashion (Intertype)—§ Scripts
Beton
Beton Bold Caps
Beton Extra Bold
Beton Open (Thompson/Bauer)
Binney Old Style #21
Bodoni Light #175
Bodoni #375
Bodoni Black (Ludlow)
Bodoni Book #875
Bodoni Bold #275
Bodoni Bold Condensed #775
Bodoni Bold Panelled #575
Bodoni Bold Recut #975
Bodoni Bold Shaded #194
Bodoni, Ultra #675
Bookman Old Style #98
Bookman, New #398
Braggadocio #278 § Sans (English)
Braille (embossing) § Unique & Foreign
Braille (printing) § Unique & Foreign
Broadway #306
Broadway Engraved #307
Bruce Old Style #31
Brush #302 § Scripts
Bulmer #462
Caledonia Bold (Intertype)
Cameo (Ludlow)
Caslon, American #637
Caslon, New #537
Caslon Old Style, English #37
Caslon Old Face (English) #128
Caslon Old Style, Inland #137
Caslon Old Style #337
Caslon Old Style #437
Caslon Old Style Bold #79
Caslon Condensed #113
Caslon Old Roman #78
Centaur (English) #252
Century Old Style #157
Century Bold #118
Century Bold Condensed #418
Century Expanded #20
Century School Book #420
Century School Book Bold #620

Chamfer Condensed #121 § Sans
Cheltenham Old Style #64
Cheltenham Old Style Bold #86
Cheltenham Bold Cond.#88
Cheltenham Bold Ext. #287
Cheltenham-Bold Ex Cond #141
Cheltenham Bold Outline #12
Cheltenham Bold Shaded #218
Cheltenham Inline #286
Cheltenham Inline Extended #285
Cheltenham Old Style Condensed #264
Cheltenham Medium #186
Cheltenham Wide #164
Cherokee — § Unique & Foreign
Chocolate Type see last page
Clearface #89 (Bold)
Clearface Italic (Light) #2891
Cloister Black #95
Cloister Bold #295
Cloister Old Style #395
Cochin #61
Cochin Bold #616
Cochin Open #262
Cochin, Nicolas #461
Cochin, Nicholas Bold #105 (Baltoype)
Compressed No. 30, #108
Comstock #202
Cooper #482
Cooper Black #282
Cooper Tooled #582
Copperplate Gothics —see Gothics
Coronet (Ludlow) — § Scripts
Coronet Bold (Ludlow) — § Scripts
Corvinus — see Glamour
Cosmopolitan #4
Craw Clarendon #65
Craw Clarendon Book #650
Cushing Old Style #25
Dante #592 (English)
Deepdene #315
Deepdene Bold #317
Della Robbia #231
Delphian (Ludlow)
DeVenne #11
DeVenne Condensed #111

DeVenne Outline #42
DeVenne Outline Italic #41
Dorchester Script § Sans
Doves
Draftsman Gothic
Eden Bold (Ludlow)
Eden Light (Ludlow)
Ehrhardt #453 (English)
Engravers Old English Bold #188
Engravers Roman #223
Engravers Bold #323
Engravers Roman #347
Engravers Text (Intertype)
Eusebius (Ludlow)
Eusebius Open (Ludlow)
Fabritius (English Monotype) #586
Farmer's Old Style #15
Flash #373— § Scripts
Flash Bold (Shaar) #473 — § Scripts
Florentine Cursive (Ludlow) § Scripts
Florentine #1 boxed ornaments (Skulls)
Formal Script (Ludlow) § Scripts
Forum Initials #274
Fournier Le Jeune #305
Frank Ruehl (Hebrew) § Foreign
French Cadmus #22
French Old Style No. 552, #71
French Round Face #150
Friedlander Initials
Futura— see Twentieth Century § Sans
Gaelic #24 (English) § Unique & Foreign
Gaelic #85 (English) § Unique & Foreign
Gallia #313
Garamond (English) #156
Garamont #248
Garamond Bold #548
Garamond, American #648
Gill Sans (English) #262 § Sans
Gill Sans Bold #275
Gill Sans Shadow #406
Gill Sans Titling Shadow #304
Glamour Light (Corvinus) #235
Glamour Medium #236
Glamour Bold #237
Glamour Condensed (Corvinus Skyline)

Gothic, Alternate No. 1, #51
Gothic, Alternate No.2, #77
Gothic, Alternate Cond. No. 3, #177
Gothic, Caps Condensed #48
Gothic, Condensed #49
Gothic, Condensed No. 124, #110
Gothic, Condensed Title #43
Gothic, Copperplate Hvy Exten. #166
Gothic, Copperplate Heavy #168
Gothic, Copperplate Heavy Cond#169
Gothic, Copperplate Light #187
Gothic, Copperplate Light #340
Gothic, Copperplate Lt. Cond #197
Gothic, Copperplate Lt. Cond #341
Gothic, Copperplate Heavy #342
Gothic, Copperplate Hvy Cond #343
Gothic, Copperplate Bold #345
Gothic, Copperplate Bold Ital #346
Gothic, Draftsman # 124
Gothic, Franklin #107
Gothic, Franklin Condensed #707
Gothic, Franklin Ex Cond #507
Gothic, Globe #240
Gothic, Globe Condensed #239
Gothic, Globe Extra Cond. #230
Gothic, Inclined #254
Gothic, Inland No 6 #149
Gothic, Jefferson—see News Gothic Ex
Gothic, Lining, Philadelphia #52
Gothic, Lining No. 545, #66
Gothic, Lining (Light) #106
Gothic, Lining No 7 (Inland) #165
Gothic, Lining Mid No. 2 #176
Gothic, Lining Mid No. 2 #276
Gothic, Lining No. 545, #349
Gothic, Lining No. 554, #129
Gothic, Modern Cond. (Tourist) #140
Gothic, News #206
Gothic, News Bold #93
Gothic, News Condensed #204
Gothic, News Extra Cond. #227
Gothic, Number 3, #249
Gothic, Octic #366
Gothic, Outline Med. Cond. (Triangle)
Gothic, Stationers Light #84

Gothic, Stationers Bold #85
Goudy Cursive #324
Goudy Hand Tooled #383
Goudy Heavyface #380
Goudy Heavyface Open # 391
Goudy Lanston #279
Goudy Modern #293
Goudy Old Style #394
Goudy Old Style Light #38
Goudy Bold #294
Goudy Open #291
Goudy Text #327
Granby Inline — § Sans Serifs
Graphic Bold (Balto) see Lucian Bold
Grasset #117
Greco Bold #326
Greek, Porson #155 § Foreign Faces
Greeting Monotone (Intertype)—Scripts
Grotesque (English) #215— § Sans
Grotesque Bold (English) #216
Grotesque Light (English) #126
Grotesque No. 2, (English) #51
Hadriano Titling #309
Half Title #905
Hauser Script (Ludlow) — § Scripts
Hebrew (Intertype #1432) § Foreign
Hebrew Ashurith #219 (English) § Foreign
Hebrew Condensed (Linotype) § Foreign
Hebrew: Peninim Pointed #217 Foreign
Hebrew: Peninim #220 Foreign
Hebrew: Sonzino #218 § Foreign
Helvetica 496 — § Sans
Helvetica Medium 508 — § Sans
Hess Bold (Goudy Bold Face) #159
Hess Old Style #242
Hess Title (Hess Bold Face) #161
Howland #139
Howland Open #96
Hungry Dutch— by Russell Maret
Imprint (English Monotype) #101
Ionic #62
Ionic / Lining Gothic No.525, #56
Ionic, Round (Inland) #156
Italian Old Style #243
Italian Old Style Wide #443

Janson #401 plus Intertype
Jefferson Gothic #227
Jenson Condensed #258
Jenson Old Style #58
Joanna 478 (English)
John Hancock #142
John Hancock Condensed # 245
Kasseler Fraktur #40 (English) § Foreign
Kasseler Fraktur #41 (English) § Foreign
Kabel Light— see Sans Serif Light #329
Kennerley Old Style #268
Kennerley Bold #269
Kennerley Open #368
Kino (English) § Sans
LatinAntique #63
Law Italic #23
Law Italic #115
Litho Roman Light (LithoAntique) #162
Lombardic Caps #310 Lanston 293 English
Lorimer (Russian (Linotype)) § Foreign
Lorrain Venus Extended
Lucian Bold #104 aka Graphic Bold
Lutetia #255 (English)
Lydian (Intertype) — § Sans
Lydian Bold (Intertype) — § Sans
MacFarland #68
Mandate (Ludlow) — § Scripts
Manila #92
Masterman #158
Mayfair Cursive (Ludlow) — § Sans
Melior #125
Melior Bold #180
Mirjam (Russian) § Unique & Foreign
Modern, Antique #26— see Antique M.
Modern, Antique Condensed #76—
see Antique Condensed Modern
Modern Condensed #1
Modern Number 3 Extra Cond. #216
Modern #8
Modern #10
Modern Medium Condensed #14
Modern Number Four, #34
Modernistic #297
Narcissus (Linotype)
News Gothic Bold #93 aka News Gothic

News Gothic Cond. #204
News Gothic #206— see Gothic, News
Nicolas Cochin #461— see Cochin, N.
Nicholas Cochin Bold — see Cochin, N
Onyx #404
Othello #246, English
Pabst Old Style #45
Parisian (Intertype)— § Sans & Scripts
Park Avenue (Intertype)— § Scripts
Pastonchi (English) #206
Pepita (English) # 613 — § Scripts
Peninim Pointed #217 — § Foreign
Perpetua (English) #239
Perpetua Titling #258 (English)
Pilot Black (Fine Press Book Ass.) § Sans
Plantin (English Monotype) #110
Plantin Bold (English Monotype) §194
Plymouth #60
Porson Greek #155 — § Foreign Faces
Post #5
Powell #97
Process #138
Remson (Linotype— Russian)
Reverse (Ludlow) — § Sans
Rivoli (Intertype)
Rockwell Antique #189 see Stymie Bold
Rockwell Antique Shaded # 193 —
Ronaldson #16
Romulus 458 (English)
Runic Condensed
Ruthenian #308 — § Foreign (Russian)
Ruthenian #318 — Ukranian / Russian
Sans Serif Light #329 — aka Kabel
Sans Serif Light Condensed #357
Sans Serif Lined #430
Sans Serif Medium #331
Sans Serif Medium Condensed #354
Sans Serif Bold #330
Sans Serif Extra Bold #332
Sans Serif Extra Bd Cond. #333
Schoeffer #69
Scotch Roman #36
Script Bold (English) #322 § Sans
Shadow (Intertype/ATF)— § Scripts
Sonzino #218 — § Foreign Faces

Spartan (English) #140 — § Gothics
Spartan Heavy (Linotype) § Gothics
Spire #377
Stellar (Ludlow) — § Sans
Stencil (ATF #662)
Stylescript #425 — § Scripts
Stymie Light #190
Stymie Medium #290
Stymie Medium Condensed #590
Stymie Bold (RockwellAntique) #189
Stymie Bold Open — see Beton Open
Stymie Bold Shaded #193 (Rockwell Shaded)
Stymie Bold #790
Stymie Extra Bold #390
Stymie Extra Bold Condensed #490
Suburban French #172
Swing Bold #217 — § Scripts
Tallone Max Factor #32
Times New Roman #327 (English)
Times New Roman Bold #334 (English)
Title #28
Title, Half #905 see Half Title
Tourist Gothic see Modern Cond Goth
Twentieth Century Ex Bold #603 §Sans
Twentieth Century Bold #604
Twentieth Century Medium #605
Twentieth Century Light #606
Twentieth Century Ex. Bold Cond #607
Twentieth Century Med. Cond #608
Twentieth Century Ultrabold #609
Twentieth Cent. Ultrabold Cond #610
Twentieth Cent. Ultra Bold Ext. #614
Typewriter Remington Ribbon 17 L
Typewriter Remington #70 L
Typewriter Reproducing #72 L
Typewriter Mailing List #74 L
Typewriter Underwood #270 L
Typewriter Remington Underscore #370L
Typewriter Reproducing Underscore #372L
Typo Roman Shaded (Intertype)
Ultra Bodoni #675 see Bodoni, Ultra
Umbra (Ludlow) — § Sans
Univers Light (English) #685
(Deberny & Peignot #45,46)— § Sans
Univers Light Cond. #686(#47,48)

Univers Medium Expand. #688 (#53)
Univers Medium #689 (D&P #55,56)
Univers Medium Cond. #690 (57,58)
Univers Medium Ex Cond. #691 (#59)
Univers Bold #693 (D&P #65,66)
Univers Bold Condensed #694 (#67,68)
Univers Extra Bold #696 (D&P #75,76)
Valiant (Shaar) #412 — § Scripts
Veronese #59 (English Monotype)
Victoria Italic #224
Wave (Ludlow) § Scripts
Wedding Text #388
Winchell #39
Winchell Condensed #119

I. Serifs

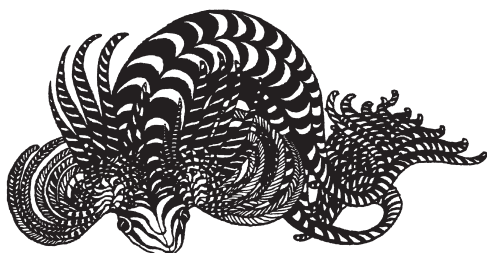

SWAMP PRESS

Adonis: see Section II: Sans Serif & Scripts
Alternate Gothics: see Section III: Gothics
American Garamond: see Garamond, American
American Caslon: see Caslon, American

Antique Bold #144

**A B C D E F G H I J K L M N O
P Q R S T U V W X Y Z & Æ Œ
a b c d e f g h i j k l m n o p q r s
t u v w x y z æ œ fi fl ff ffi ffl
\$ 1 2 3 4 5 6 7 8 9 0 £ ., - ' : ; ! ?**

DISPLAY: Roman: 14, 18, 24, 30 (fonts, sorts, hand-setting only)

Antique, Bold Condensed #145

**A B C D E F G H I J K L M N O P Q R
S T U V W X Y Z & Æ Œ
a b c d e f g h i j k l m n o p q r s t u
v w x y z æ œ fi fl ff ffi ffl
\$ 1 2 3 4 5 6 7 8 9 0 £ ., - ' : ; ! ?**

DISPLAY: Roman: 14, 18, 24, 30, 36

Antique, Modern #26

**A B C D E F G H I J K L M N O P Q R S T U V W X Y Z & Æ Œ
a b c d e f g h i j k l m n o p q r s t u v w x y z æ œ f i f f f f f f f l
\$ 1 2 3 4 5 6 7 8 9 0 ., - ' : ; ! ?**

Roman Composition: 8, 10, 12, 14 (+ accents) (fonts, sorts & machine composition)

Antique, Modern Condensed #76

ABCDEFGHIJKLMNOPQRSTUVWXYZ&ÆŒ

abcdefghijklmnopqrstuvwxyzaeæ fi fl ff ffi fl

\$1234567890 .,-' :;!?

Roman Composition: 9

Antique Old Style #161 (English Monotype)†

ABCDEFGHIJKLMNOPQRSTUVWXYZ

abcdefghijklmnopqrstuvwxyzaeæ fi fl ff ffi fl

ABCDEFGHIJKLMNOPQRSTUVWXYZ

abcdefghijklmnopqrstuvwxyzaeæ fi fl ff ffi fl

&ÆŒ .,:;!?'-([†\$£*—£])-''?!;:,. &ÆŒ

ALTERNATIVE FIGURES F235

1234567890

1234567890

1234567890

Roman: 14, 18, 24 (all large composition)

Artcraft (Ludlow) (Lanston Monotype specimen shown)

(c. 1930, originally designed for BB&S by Robert Wiebking)

A B C D E F G H I J K L M N O P

Q R S T U V W X Y Z &

a b c d e f f g h i j k l m n o p q r s t u

v w x y z fi fl ff ffi fl

\$ 1 2 3 4 5 6 7 8 9 0 .,-' :;!?

Roman: 18 (Special Ludlow casting only)

†Note: There were two companies making Monotype machines and matrices: the Lanston Monotype Machine Company based in Philadelphia, and The Monotype Corporation Limited, based in England. Although American and English mats and machines were engineered to be incompatible, we can work around that and cast from either type of matrix. Lanston comp mats have a 0.030" drive, English Monotype 0.050".

BAKER

BY RUSSELL MARET

An original font designed by Russell Maret, & cast from matrices engraved at Swamp Press. The design is based on letter carvings on the Tomb of Eurysaces the Baker (ca. 50-20BC) outside Rome, Italy.

A B C D E F G H I J K L M N O P
Q R S T U V W X Y Z & | T
\$ 1 2 3 4 5 6 7 8 9 0 - . , ; : ! ? ' ' - ' •

24 Point 1/4 strength font (8A)
with extra kerned characters and
Tall "I" and "T" on 30 pt bodies \$125.
(1/2 strength, \$225)

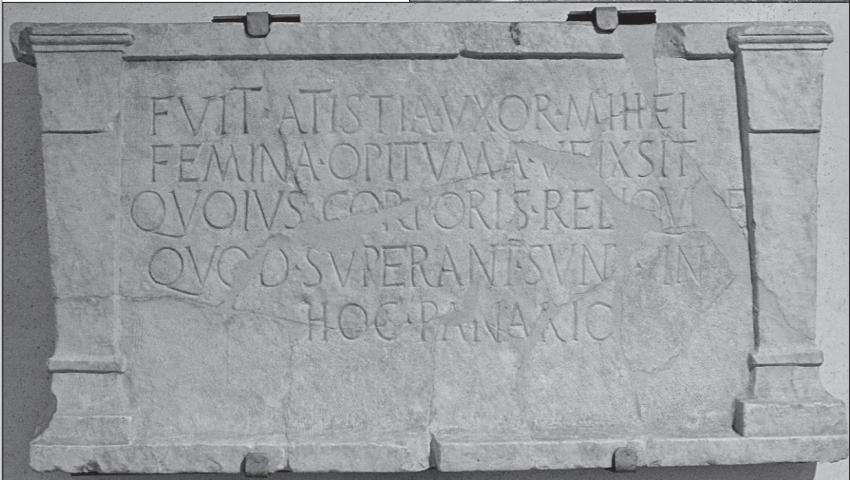

Baskerville (English Monotype) #169

(c. 1923 rendition of the type used by Baskerville in his 1757 quarto *Virgil*.)

ABCDEFGHIJKLMNOPQRSTUVWXYZ&ÆŒ

ABCDEFGHIJKLMNOPQRSTUVWXYZ&ÆŒ

abcdefghijklmnopqrstuvwxyzfiflffiffllæœ

ABCDEFGHIJKLMNOPQRSTUVWXYZ&ÆŒ

abcdefghijklmnopqrstuvwxyzfiflffiffllæœ

1234567890 .,:;!?'-([†‡§£\$*—\$'?!;:, 1234567890

Roman, Italic, SMALL CAPS Composition: 8, 9, 10, 11, 12; + Quaints;

Roman Large Composition: 14, 18

Small Composition: 12 on 14 Long ascenders & descenders

DISPLAY: Roman & Italic: 14, 18, 24, 30, 36

Baskerville #353

ABCDEFGHIJKLMNOPQRSTUVWXYZ&ÆŒ

abcdefghijklmnopqrstuvwxyzæœ

\$1234567890 \$1234567890

fi fl ff ffi ffl .,-'':;! ? f fi ff ft ffi et

ABCDEFGHIJKLMNOPQRSTUVWXYZ&ÆŒ

ABCDEFGHIJKLMNOPQRSTUVWXYZ&ÆŒ

abcdefghijklmnopqrstuvwxyzæœ

\$1234567890 \$1234567890

fi fl ff ffi ffl :;! ? f fi ff ft ffi et

Roman, Italic & SMALL CAPS Composition: 6, 7, 8, 9, 10, 11, 12 + accents & quaints

DISPLAY: Roman & Italic: 14, 18, 24, 30, 36

Baskerville Bold #453

ABCDEFGHIJKLMNOPQRSTUVWXYZ&

abcdefghijklmnopqrstuvwxyz fiflffiffll

\$1234567890 .,-'':;! ? () []

Roman Composition: 8, 9, 10, 11, 12

Bell (English Monotype) #341

c. 1932 copy based on the original punches & matrices by John Bell (1745-1831)

ABCDEFGHIJKLMNOPQRSTUVWXYZ&ÆŒ

ABCDEFGHIJKLMNOPQRSTUVWXYZÆŒ

abcdefghijklmnopqrstuvwxyzfiflffiffllæœ

ABCDEFGHIJKLMNOPQRSTUVWXYZ&ÆŒ

abcdefghijklmnopqrstuvwxyzfiflffiffllæœ

1234567890 1234567890

.,:;!?'-([†‡§£\$*—\$§†‡])'?!;:,

Roman composition: 14 Display Italic: 14

Bembo (English Monotype) #270

Brought out by Stanley Morison c. 1929, based on Griffo's roman for Cardinal Bembo's *de Aetna* of 1495, published by Aldus Manutius.

The companion italic based on Tagliente's Chancery cursive c. 1529.

ABCDEFGHIJKLMNOPQRSTUVWXYZ&ÆŒ

ABCDEFGHIJKLMNOPQRSTUVWXYZ&ÆŒ

abcdefghijklmnopqrstuvwxyzfiflffiffllæœ

ABCDEFGHIJKLMNOPQRSTUVWXYZ&ÆŒ

abcdefghijklmnopqrstuvwxyzfiflffiffllæœ

1234567890 .,:;!?'-([†‡§£\$*—\$§†‡])'?!;:, 1234567890

SELECTED ALTERNATIVE AND ADDITIONAL CHARACTERS

234567890 F 537 R 203 M 145 R 224 1234567890 F 538

Roman, Italic & SMALL CAPS Composition: 6, 8, 9, 10, 11, 12, 13, 14 + accents

Roman & Italic Large Composition: 16

Bembo #405 (Lanston)

ABCDEFGHIJKLMNOPQRSTUVWXYZ&ÆŒ

abcdefghijklmnopqrstuvwxyzæœ fiflfffffl

\$1234567890 .,-“:;! ? [] () * + § \$ I 2 3 4 5 6 7 8 9 0

ABCDEFGHIJKLMNOPQRSTUVWXYZ&ÆŒ

ABCDEFGHIJKLMNOPQRSTUVWXYZ&ÆŒ

abcdefghijklmnopqrstuvwxyzæœ fiflfffffl

\$1234567890 ;! ? \$1234567890

Roman & Italic Display: 14, 18, 24, 30, 36

Bembo Bold (English Monotype) #428

ABCDEFGHIJKLMNOPQRSTUVWXYZ&ÆŒ

abcdefghijklmnopqrstuvwxyzfiflffffflæœ

ABCDEFGHIJKLMNOPQRSTUVWXYZ&ÆŒ

abcdefghijklmnopqrstuvwxyzfiflffffflæœ

1234567890

1234567890

.,:;! ? “-(†‡\$£\$*—\$£\$††)’“? ! ; , :

ALTERNATIVE CHARACTERS

1234567890 F839

f 180

ff 231

R 203

R 224

1234567890 F1390

Roman and Italic Composition: 8, 9, 10, 12, 14 + accents

Below a Monotype caster moving a new line of type into the galley.

Note the lines are justified with all spacing included.

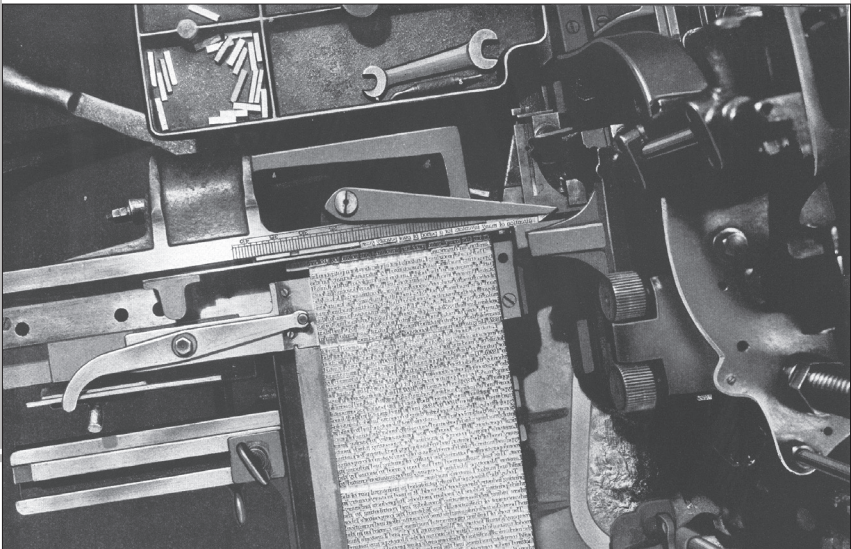

Letter Anatomy

hook or lobe



stem

bowl

arches



waist line

serif

serif line or base line

beak



ascender line

ascender

counter

swell

descender

descender or drop line

Ben Franklin Initials #127

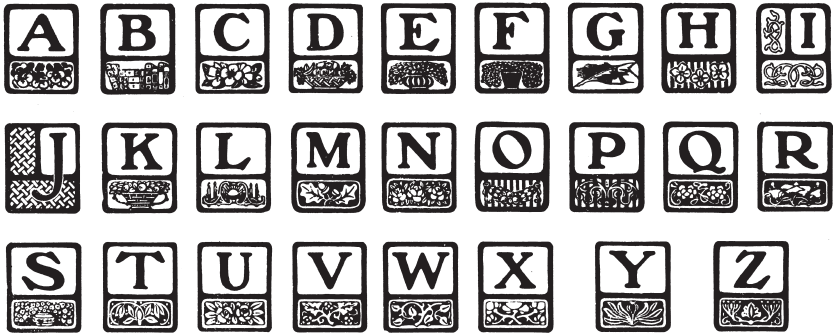

DISPLAY casting: 36

Bernhard Fashion — see Scripts

THE MONOTYPE KEYBOARD AND



The Keyboard

which handles with equal facility all kinds of copy from the plainest to the most intricate, setting it in any measure up to 90 ems. The universal arrangement of the keys makes it easy to operate, and its speed is so great that no operator can possibly be fast enough to stall it.

Composing Machine

This Machine produces all kinds of composition in any size of type from 4-point to 18-point in any measure up to 84 picas.

Type-&-Rule Caster

casts type in all sizes from 4-point to 36-point: Body Type, Display Type, Borders, Rules, Leads, Slugs, Spaces, and Quads.

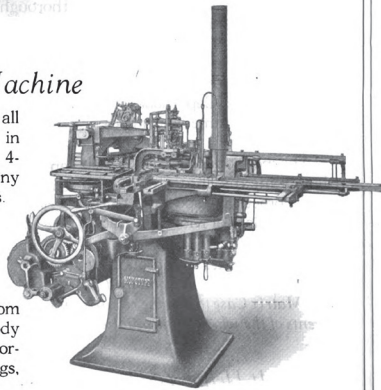

Beton (Linotype; Digital specimen below)
(Designed by Heinrich Jost, for Bauer, c 1931)

ABCDEFGHIJKLMNOPQRSTUVWXYZ
abcdefghijklmnopqrstuvwxyz ,;:!'?\$1234567890

Special DISPLAY casting: 12, 14, 36

Beton Bold Caps (Linotype; Digital specimen below)

ABCDEFGHIJKLMNOPQRSTUVWXYZ

Special DISPLAY casting: 30

Beton Extra Bold (Linotype; Digital specimen below)

ABCDEFGHIJKLMNOPQRSTUVWXYZ

Special DISPLAY casting: 18, 30, 36

Beton Open[†] (Bauer)^{††} aka “Antique Open” or “Stymie Bold Open”

ABCDEFGHIJKL
MNOPQRSTUVWXYZ&
\$1234567890 ,.-:;'?!?(!)

DISPLAY: 24# 1 = 20 point [†]Electroplated Thompson Mats

^{††}In the parens is listed the foundries that made the mats and in this case the specimen is taken from Typefounders of Chicago. To make matters more complicated my matrices were probably made by the Thompson company. These mats were made by electro-depositing copper into a brass blank into which was inserted a piece of lead type. Once the electroplating was complete, the type was removed and the mat machined, making it was ready for casting. This method was used both legitimately (most Lanston Monotype display mats were made this way) and as a way to pirate designs from other foundries. Composition and English Display mats were made by plunging a hardened steel punch into brass, bronze or aluminum.

Binney Old Style #21

(Similar to Ronaldson, cut in Scotland c. 1863)

ABCDEFGHIJKLMNOPQRSTUVWXYZ&ÆŒ

abcdefghijklmnopqrstuvwxyzæœ fiffiffiffi

\$1234567890 .,-' :;! ? \$I234567890

ABCDEFGHIJKLMNOPQRSTUVWXYZ&ÆŒ

ABCDEFGHIJKLMNOPQRSTUVWXYZ&ÆŒ

abcdefghijklmnopqrstuvwxyzæœ fiffiffiffi

\$1234567890 :;! ? \$I234567890

Roman & Italic Composition: 4 1/2, 6, 7, 8, 10, 11, 12 + accents

SMALL CAPS: 4 1/2, 7, 8, 11, 12

DISPLAY: Roman: 14, 18, 24, 30, 36

Bodoni Black (Ludlow # 3-H)

Characters in Complete Font

A B C D E F G H

I J K L M N O P

Q R S T U V W

X Y Z & \$ 1 2 3

4 5 6 7 8 9 0

a b c d e f g h i

j k l m n o p q r

s t u v w x y z

. , ; - ' ° ! ? - () [] ♦

The per cent mark is made for all sizes.
It may be purchased separately.

%

DESIGNS 67 **Rare models**

24 Point Ludlow 3-H Bodoni Black
Length of lower-case alphabet: 386 points

GOOD DESIGN 10 **For display heads**

18 Point Ludlow 3-H Bodoni Black
Length of lower-case alphabet: 284 points

VALUABLE TIME IS 11 **Saved with this system**

14 Point Ludlow 3-H Bodoni Black
Length of lower-case alphabet: 216 points

DISPLAY TYPEFACES 45 **Are ever in active demand**

12 Point Ludlow 3-H Bodoni Black
Length of lower-case alphabet: 186 points

A LUDLOW TYPE DESIGN 12 **For newspaper display heads**

10 Point Ludlow 3-H Bodoni Black
Length of lower-case alphabet: 167 points

(not shown to size)

Special DISPLAYcasting: Roman: 24, 36, 60

Bodoni Light #175

Bodoni was created by Giambattista Bodoni c. 1760-1810 and was immensely popular up to the 1850's. Morris Fuller Benton of ATF popularized revised versions 1908-1915, and Bauer Bodoni, c. 1926 by Heinrich Jost is yet another updated version.

ABCDEFGHIJKLMNOPQRSTUVWXYZ&ÆŒ

abcdefghijklmnopqrstuvwxyzæœ fiffiffiffi

\$1234567890 .,-":;!\$ 1234567890

ABCDEFGHIJKLMNOPQRSTUVWXYZ&ÆŒ

ABCDEFGHIJKLMNOPQRSTUVWXYZ&ÆŒ

abcdefghijklmnopqrstuvwxyzæœ fiffiffiffi

\$1234567890 :;!?

Roman Composition: 6, 7, 8, 9, 10, 12 + accents

Italic: 6, 7, 9, 10, 12

SMALL CAPS: 6, 7, 9, 10, 12

DISPLAY: Roman & Italic: 14, 18, 24, 30, 36

Bodoni #375

ABCDEFGHIJKLMNOPQRSTUVWXYZ&

abcdefghijklmnopqrstuvwxyz fiffiffiffi

\$1234567890 .,-":;!?

ABCDEFGHIJKLMNOPQRSTUVWXYZ&

ABCDEFGHIJKLMNOPQRSTUVWXYZ&

abcdefghijklmnopqrstuvwxyz fiffiffiffi

\$1234567890 .,-":;!?

Roman & Italic & SMALL CAPS Composition: 6, 7, 8, 9, 10, 11, 12,

Roman & Italic Large Composition: 14, 18

DISPLAY: Roman: 14, 18, 24, 30, 36, 42, 48, 72

Italic: 14, 18, 24, 30, 36, 42, 48, 60, 72

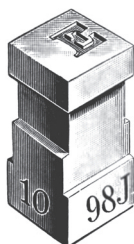

The Monotype cellular composition matrix has a punched cavity at the top into which molten type metal is injected—which forms the printing surface of a piece of movable type. In the standard 15x15 matrix case 225 mats are arranged in 15 rows of 15 mats. Each row casts type with the same set width, thus in theory 15 set-sizes may be cast from one matrix case.

Bodoni Book #875

ABCDEFGHIJKLMNOPQRSTUVWXYZ&

abcdefghijklmnopqrstu vwxyz fiffiffiffi

\$1234567890 .,- ' " " : ; ! ? () []

ABCDEFGHIJKLMNOPQRSTUVWXYZ&

ABCDEFGHIJKLMNOPQRSTUVWXYZ&

abcdefghijklmnopqrstu vwxyz fiffiffiffi

\$1234567890 : ; " " ! ?

Roman, Italic & SMALL CAPS Composition: 6, 7, 8, 9, 10, 11, 12

DISPLAY: Roman: 14, 24, 30

Italic: 14 (inc), 18, 24, 30, 36

Bodoni Bold #275

ABCDEFGHIJKLMNOPQRSTUVWXYZ&ÆŒ

abcdefghijklmnopqrstu vwxyzæœ fiffiffiffi

\$1234567890 .,- " " : ; ! ?

ABCDEFGHIJKLMNOPQRSTUVWXYZ&ÆŒ

abcdefghijklmnopqrstu vwxyzæœ fiffiffiffi

\$1234567890 .,- " " : ; ! ?

Roman & Italic Composition: 6, 7, 8, 9, 10, 11, 12

DISPLAY: Roman & Italic: 14, 18, 24, 30, 36, 42, 48, 60, 72

Bodoni Bold Condensed #775

A B C D E F G H I J K L M N O P Q R S

T U V W X Y Z &

a b c d e f g h i j k l m n o p q r s t u v

w x y z fi fl ff ffi ffl

\$ 1 2 3 4 5 6 7 8 9 0 . , - ' ' : ; ! ?

DISPLAY: Roman: 14, 18, 24, 30, 36, 42, 60, 72, 72H4

Bodoni Bold Panelled #575

A B C D E F G H I J K L
M N O P Q R S T U V W
X Y Z & I C

DISPLAY: Roman: 24, 30, 36, 36H4 *

* Lanston's "H4" designation stands for a "Titling" version, in other words there is no lower case or descender position, so the whole body is taken up with the capitals. Thus a 36H4 reads much larger than the body size of 36 point suggests, and a cap in 72 point regular would be much smaller in height.

Bodoni Bold Shaded #194

A B C D E F G H I J K L M N O P Q R S T U V W X Y Z &
a b c d e f g h i j k l m n o p q r s t u v w x y z f i f f f f f i f f l . , ; - ' ! ?
\$ 1 2 3 4 5 6 7 8 9 0

DISPLAY: Roman: 12, 14, 18, 24, 30, 36

Bodoni, Ultra #675

A B C D E F G H I J K L M N O P
Q R S T U V W X Y Z & Æ Œ
a b c d e f g h i j k l m n o p q r s t
u v w x y z æ œ
\$ 1 2 3 4 5 6 7 8 9 0 . , - ' ° : ; ! ? [] ()
A B C D E F G H I J K L M N O P
Q R S T U V W X Y Z &
a b c d e f g h i j k l m n o p q r s
t u v w x y z . , - ' ° : ; ! ?
\$ 1 2 3 4 5 6 7 8 9 0

DISPLAY: Roman & Italic: 8, 10, 12, 14, 18, 24, 30, 36, 42, 48, 60, 72

Bodoni, Recut Bold #975

ABCDEFGHIJKLMNOPQRSTUVWXYZ&ÆŒ
abcdefghijklmnopqrstuvwxyzæœ fififfiffi
\$1234567890 .,-‘’“”::!?

Roman Composition: 6, 7, 8, 9, 10, 11, 12

Bookman Old Style #98 aka Antique Old Style

Originally made as a bold for Miller & Richard's "Old Style" c. 1925 by Ludlow

ABCDEFGHIJKLMNOPQRSTUVWXYZ&ÆŒ
abcdefghijklmnopqrstuvwxyzæœ fififfiffi
\$1234567890 .,-‘’::!?

ABCDEFGHIJKLMNOPQRSTUVWXYZ&ÆŒ

ABCDEFGHIJKLMNOPQRSTUVWXYZ&ÆŒ
abcdefghijklmnopqrstuvwxyzæœ fififfiffi
\$1234567890 .,-‘’::!?

Roman & Italic & SMALL CAPS Composition: 6, 7, 8, 9, 10, 11, 12
DISPLAY: Roman & Italic: 14, 18, 24, 30, 36 Roman only 20, 48

Bookman, New #398

A B C D E F G H I J K L M N O
P Q R S T U V W X Y Z & Æ Œ
a b c d e f g h i j k l m n o p q r s
t u v w x y z æ œ fi fl ff ffi ffl
\$ 1 2 3 4 5 6 7 8 9 0 £ ., - ' : ; ! ?

DISPLAY: Roman: 14, 18, 24, 30, 36, 48, 60, 72

Braille: see Unique Faces section

Broadway #306

A B C D E F G
H I J K L M N O
P Q R S S S T
U V W X Y Z &
\$ 1 2 3 4 5
6 7 8 9 0
a b c d e f g h i
j k l m n o p q
r s s t u v w x
y z . , ; : - ' ! ?

DISPLAY: Roman: 12, 14, 18, 24, 30, 36

Broadway Engraved #307

A B C D E F
G H I J K L
M N O P Q R
S S S S T U V
W X Y Z & \$
1 2 3 4 5 6
7 8 9 0 . , ; :
- ' ! ?

DISPLAY: Roman: 14, 18, 24, 30, 36

Bruce Old Style #3 I

By Sol Hess in 1909, based on the Bruce Foundry Old Style #20 of 1869.

ABCDEFGHIJKLMNOPQRSTUVWXYZ&ÆŒ

abcdefghijklmnopqrstuvwxyæœ fiffiffiffi

\$1234567890 .,-':;! ? \$1234567890

ABCDEFGHIJKLMNOPQRSTUVWXYZ&ÆŒ

ABCDEFGHIJKLMNOPQRSTUVWXYZ&ÆŒ

abcdefghijklmnopqrstuvwxyæœ fiffiffiffi

\$1234567890 ;:!? \$1234567890

Roman, Italic & SMALL CAPS Composition: 6, 7, 8, 9, 10, 11, 12 + accents

Bulmer #462

This is the Lanston version, The English version which I don't have is c. 1936 based on William Martin's design cut for William Bulmer in about 1790

ABCDEFGHIJKLMNOPQRSTUVWXYZ&

abcdefghijklmnopqrstuvwxy fiffiffiffi .,-':;! ? () —

\$1234567890% ¼ ½ ¾ ⅛ ⅜ ⅝ ⅞ \$1234567890

ABCDEFGHIJKLMNOPQRSTUVWXYZ&

ABCDEFGHIJKLMNOPQRSTUVWXYZ&

abcdefghijklmnopqrstuvwxy fiffiffiffi

\$1234567890 ,-'':;! ? \$1234567890

Roman, Italic & SMALL CAPS Composition: 6, 7, 8, 9, 10, 11, 12

DISPLAY: Roman & Italic: 14, 16, 18, 24, 30, 36



Display Matrix

Typical "flat mat" for display casting. Since it is hand-loaded into the caster (Monotype Orphan Annie, Type & Rule Caster; Thompson, English Monotype Supercaster or Lanston Giant Caster) only sorts casting is possible. When making up fonts each matrix is loaded and the appropriate number of casts performed, then the next matrix & etc. until enough type is made to hand-assemble into fonts. The comp caster can make fonts in a single run all on its own.

Caledonia Bold (Linotype)*

ABCDEFGHIJKLMN OPQRSTUVWXYZ
WXYZ&\$1234567890.,-;:'!?(†‡*‡§
abcdefghijklmnopqrstuvwxy z

Special DISPLAY casting: 18 (18Δ445)

*Linotype and Intertype were competitors with Monotype and made slug-casting machines. With a special mold and holder normal hand-set type may be cast from these mats on the Thompson caster; although the process is very slow and of course machine composition is impossible on the Thompson.

Cameo (Ludlow #19)

R.H. Middleton circa 1926. Perhaps one of his first designs for Ludlow.

Seems to be an open face for Caslon.

For Fine Contrast 59

24 Point Ludlow No. 19 Cameo, 12 to 72 Point

Special DISPLAY casting: Roman: 12, 14, 18, 24, 30*

*(Caps only)

Giant type. Note the two hollows inside the type body. Giant type has a depth of drive of 0.065" in most cases, deeper than Lanston composition Monotype (0.030"), or English composition (0.050") or Thompson / Lanston / English Display to 36 point: 0.050". The "depth of drive" is the business end of the character that rises up from the body, and includes the face and beard.



Giant Caster Matrix

Caslon, American #637

A B C D E F G H I J K L M N O P Q R S
T U V W X Y Z &

a b c d e f g h i j k l m n o p q r s t u v
w x y z fi fl ff ffi ffl

\$ 1 2 3 4 5 6 7 8 9 0 . , - ' ' : ; ! ?

DISPLAY: Roman: 42, 60, 72; Italic: 42, 48, 60, 72

A B C D E F G H I J K L M N O P Q R S
T U V W X Y Z &

a b c d e f g h i j k l m n o p q r s t u v w
x y z fi fl ff ffi ffl

\$ 1 2 3 4 5 6 7 8 9 0 . , - ' ' : ; ! ?

Caslon, New #537

A B C D E F G H I J K L M N O P Q
R S T U V W X Y Z & Æ

a b c d e f f g h i j k l m n o p q r s t u
v w x y z æ fi fl ff ffi ffl

\$ 1 2 3 4 5 6 7 8 9 0 . , - ' ' : ; ! ?

A B C D E F G H I J K L M N O
P Q R S T U V W X Y Z &

a b c d e f g h i j k l m n o p q r s t
u v w x y z fi fl ff ffi ffl

\$ 1 2 3 4 5 6 7 8 9 0 . , - ' ' : ; ! ?

DISPLAY: Roman: 14, 18, 24, 30, 36, 48 G

Italic: 14, 18, 24, 30, 36

Caslon Old Style, English #37 (Lanston)[†]

ABCDEFGHIJKLMNOPQRSTUVWXYZ&ÆŒ

abcdefghijklmnopqrstuvwxyzæœ fiffiffiffi

\$1234567890 .,-':;! ? \$I234567890

ABCDEFGHIJKLMNOPQRSTUVWXYZ&ÆŒ

ABCDEFGHIJKLMNOPQRSTUVWXYZ&ÆŒ

abcdefghijklmnopqrstuvwxyzæœ fiffiffiffi

\$1234567890 :;! ? \$I234567890

Roman, Italic & SMALL CAPS Composition: 6, 7, 8, 9, 10, 11, 12; (7 no SMALL CAPS)

DISPLAY: Roman & Italic: 14, 18, 24, 30, 36

Also see Foreign section for 30 pt Greek version of this face.

Caslon Old Face (English Monotype) #128

c. 1915 made from a Caslon specimen of 1734

ABCDEFGHIJKLMNOPQRSTUVWXYZ&ÆŒ

ABCDEFGHIJKLMNOPQRSTUVWXYZ&ÆŒ

abcdefghijklmnopqrstuvwxyzfiffiffiffiæœ

ABCDEFGHIJKLMNOPQRSTUVWXYZ&ÆŒ

abcdefghijklmnopqrstuvwxyzfiffiffiffiæœ

I 234567890 .,:;!?'-([†‡§£\$—“?!,;:,*

Roman, Italic, small caps 12; swash + quints (with long s)

Roman & Italic Large Composition: 18, 24

Caslon began in 1725 with William Caslon starting the Caslon Type Foundry which endured for three generations. The faces were based on 17th century Dutch types. Versions of Caslon were introduced in a specimen sheet in 1734. The US Constitution and Declaration of Independence were both printed in Caslon.

Caslon Old Style, Inland #137

ABCDEFGHIJKLMNOPQRSTUVWXYZ&ÆŒ

abcdefghijklmnopqrstuvwxyæœ fiffiffiff

\$1234567890 .,-“”;! ? \$1234567890

ABCDEFGHIJKLMNOPQRSTUVWXYZ&ÆŒ

ABCDEFGHIJKLMNOPQRSTUVWXYZ&ÆŒ

abcdefghijklmnopqrstuvwxyæœ fiffiffiff

\$1234567890 ;;! ? \$1234567890

Roman, Italic & SMALL CAPS Composition: 8, 9, 10, 12

Caslon Old Style (Mackellar) #337

ABCDEFGHIJKLMNOPQRSTUVWXYZ&ÆŒ

abcdefghijklmnopqrstuvwxyæœ fiffiffiff

\$1234567890 .,-“”;! ? \$1234567890

ABCDEFGHIJKLMNOPQRSTUVWXYZ&ÆŒ

ABCDEFGHIJKLMNOPQRSTUVWXYZ&ÆŒ

abcdefghijklmnopqrstuvwxyæœ fiffiffiff

\$1234567890 .,-“”;! ? \$1234567890

Roman, Italic & SMALL CAPS Composition: 7, 8, 9, 10, 11, 12 + accents

Long Descenders: 7, 8, 9, 10, 11, 12

DISPLAY: Roman & Italic: 14, 18, 24, 30, 36, + R: 22, 36H4

SMALL CAPS: 14, 18, 24

Swash: 11, 14, 18, 24, 30, 36, 42, 48

Quaint Characters: Roman & Italic: 14, 18, 24, 30, 36 (all incomplete.)

† I know this is confusing, but Lanston called the font “English Caslon Old Style” and the face has nothing to do with English Monotype in England. By the way, operating out of London, Monotype Hot Metal is the successor of “The Monotype Corporation Limited” (aka English Monotype) and is still punching Monotype composition matrices up to 24 point.

THE ORIGINAL OLD CASLON ON THE MONOTYPE

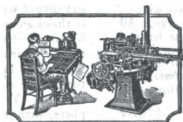

THIS NEW MONOTYPE CASLON (the No. 337 Series) is a faithful reproduction of a face that has steadfastly maintained its popularity in spite of defilement by designers who have distorted this beautiful old face to suit the so-called "standard life" and in other ways endeavored to "modernize" a classic.

WE confidently rest our typographic reputation upon this real Caslon, for, although these matrices have been made in the cellular sizes from 7 to 12 point, for use on a composing machine, surely there is nothing "machinery" about the face here shown; all the charm of the original hand-cut letters has been preserved.

CASLON should be set leaded, and therefore we have made the face with its distinctive long descenders; for those who must set this face solid, almost a desecration, we have provided, in the cellular point sizes, matrices for the shortened descenders, but these are much less stubby than the descenders of most of the modern adaptations of this face.

ONE other point should be noted; Caslon was made to be printed upon hand-made paper—there was no machine-finish in those good old days. We have not attempted the impossible, to make a face that would be Caslon under totally different printing conditions.

WE have two other Caslons, the Nos. 37 and 137E Series; therefore we have made this new-old Caslon for our own satisfaction and to delight those who love to mix type, paper and brains. To show the great difference that paper makes in this face we here print it both on antique and on coated paper. *In ordering, please be sure to specify whether you wish the long or the short descenders.*

*A faithful reproduction of the real old Caslon Series cut in the
year 1720, by William Caslon, the first, of London*

Fonts of Matrices of the No. 337 Series shown on these pages are sold at Class A prices
NOT INCLUDED IN MATRIX LIBRARY AND WILL NOT BE LEASED

Caslon Old Style #437

A B C D E F G H I J K L M N O P

Q R S T U V W X Y Z &

a b c d e f g h i j k l m n o p q r s t u v

w x y z fi fl ff ffi ffl

\$ 1 2 3 4 5 6 7 8 9 0 . , - ' : ; ! ?)

A A B B C C D D E E F G G H I J J

K K L L M M N N O P P Q Q R R

S T T U V U W X Y Y Z &

a b c d e f g h i j k k l m n o p q r s t u v

v w w x y z z et fi fl ff ffi ffl

\$ 1 2 3 4 5 6 7 8 9 0 . , - ' : ; ! ?

DISPLAY: Roman: 42, 48, 72

Italic: 42, 48, 60, 72

True-Cut Caslon (Ludlow)

Special Display Casting: 22 pt Roman

Characters in Complete Font

A B C D E F G H I J K

L M N O P Q R S T U V

W X Y Z & \$ 1 2 3 4 5 6

7 8 9 0 a b c d e f g h i j k

l m n o p q r s t u v w x y z

ff fi ffi fl ffl . : , ; - ' ! ? () —

Other sizes available on special request: 18, 24, 30, 42, 48 ^{SE}

Caslon Old Style Bold #79

ABCDEFGHIJKLMNOPQRSTUVWXYZ&ÆŒ

abcdefghijklmnopqrstuvwxyzæœ fi fl ff ffi ffl

\$1234567890 .,-“”:;!?

Standard C2 Arrangement for sizes up to and including 12 Point. Special Arrangement for 14 and 18 Point.

(Can be combined in Special Arrangement with Caslon Bold Italic for Monotype Machine Typesetting in sizes up to and including 12 Point.)

Machine Typesetting – 5 to 12 Point, 82 Characters; 14 and 18 Point, 78 Characters

Long Descenders in 6, 8, 10 and 12 Point: **g j p q y**

ABCDEFGHIJKLMNOPQRSTUVWXYZ&ÆŒ

(Small Caps are available in 9, 10, 11 and 12 Point and can be combined in Special Arrangement with Caslon Bold and Caslon Bold Italic.)

Roman Composition: 5, 6, 7, 8, 9, 10, 11, 12

Italic Composition: 6, 8, 10, 12

DISPLAY: Roman & Italic: 14, 18, 24, 30, 36, 42, 48, 60, 72

Accents: Roman: 14, 18, 24, 30, 36

Caslon Condensed #113

ABCDEFGHIJKLMNOPQRSTUVWXYZ&ÆŒ

abcdefghijklmnopqrstuvwxyzæœ fi fl ff ffi ffl

\$1234567890 .,-“”:;!?

Roman Composition: 6, 8, 10, 12

DISPLAY: Roman: 14, 18, 24, 30, 36, 60, 72

Caslon Old Roman #78

A B C D E F G H I J K L M N O P Q

R S T U V W X Y Z & Æ Œ

a b c d e f g h i j k l m n o p q r s t u v w x y z

æ œ fi fl ff ffi ffl \$1234567890£ .,-“”:;!?

Roman Composition: 6, 8, 10, 12

DISPLAY: Roman: 14, 18, 24, 36

Centaur (English Monotype) #252

c. 1929 by Bruce Rogers, based on Robert Wiebking's cuttings in 1914, ultimately based on Jenson's 1470 Venetian face. The italic, Arrighi, was designed by Frederick Warde and based on Chancery Face used by Arrighi in 1524.

ABCDEFGHIJKLMNOPQRSTUVWXYZ&ÆŒ

ABCDEFGHIJKLMNOPQRSTUVWXYZ&ÆŒ

abcdefghijklmnopqrstuvwxyzfiflffiffllæœ

ABCDEFGHIJKLMNOPQRSTUVWXYZ&ÆŒ

abcdefghijklmnopqrstuvwxyz fiflffiffllæœ

1234567890 .,:;!?'-([†‡§£\$*—\$£†‡])-‘?!,:,. 1234567890

Roman, Italic & SMALL CAPS Composition: 10, 12 + accents;

Large Composition Roman & Italic: 14, 16, 18, 24

DISPLAY: Roman 30, 36

—See Eusebius and Eusebius Open for a nice companion display face—

Century Old Style #157

Designed by De Vinne and Linn Boyd Benton for the Century magazine in 1894. They wanted a darker, more readable face. Morris F. Benton designed more versions at ATF around 1900.

ABCDEFGHIJKLMNOPQRSTUVWXYZ&ÆŒ

abcdefghijklmnopqrstuvwxyzæœ fiflffiffll

\$1234567890 .,-‘:;!?

ABCDEFGHIJKLMNOPQRSTUVWXYZ&ÆŒ

ABCDEFGHIJKLMNOPQRSTUVWXYZ&ÆŒ

abcdefghijklmnopqrstuvwxyzæœ fiflffiffll

\$1234567890 :;!?

Roman, Italic & SMALL CAPS Composition: 6, 8, 9, 10, 12

DISPLAY: Roman: 14, 18, 36

Century Bold #118

ABCDEFGHIJKLMNOPQRSTUVWXYZ&ÆŒ

abcdefghijklmnopqrstuvwxyzæœ fiffiffiffi

\$1234567890 .,-“:;!?

ABCDEFGHIJKLMNOPQRSTUVWXYZ&ÆŒ

abcdefghijklmnopqrstuvwxyzæœ fiffiffiffi

\$1234567890 .,-“:;!?

Roman Composition: 6, 8, 10, 12

Italic Composition: 8, 10, 12

DISPLAY: Roman: 14, 18, 24, 30, 36, 48, 72

Italic: 14, 18, 24, 30, 36

Century Bold Condensed #418

(Digital specimen below)

ABCDEFGHIJKLMNOPQRSTUVWXYZ

abcdefghijklmnopqrstuvwxyz ,.:?! \$1234567890

Roman Display: 24, 30, 36

Century Expanded #20

ABCDEFGHIJKLMNOPQRSTUVWXYZ&ÆŒ

abcdefghijklmnopqrstuvwxyzæœ fiffiffiffi

\$1234567890 .,-“:;!?

ABCDEFGHIJKLMNOPQRSTUVWXYZ&ÆŒ

ABCDEFGHIJKLMNOPQRSTUVWXYZ&ÆŒ

abcdefghijklmnopqrstuvwxyzæœ fiffiffiffi

\$1234567890 :;!?

Roman, Italic & SMALL CAPS Composition: 6, 7, 8, 9, 10, 11, 12

Large Composition: 14 Italic

DISPLAY: Roman: 14, 18, 24, 30, 36, 42

Italic: 14, 18, 24, 30, 36

Century School Book #420

Based on the type made for *Century* magazine in 1894

ABCDEFGHIJKLMN**OP**QRSTUVWXYZ&
abcdefghijklmnopqrstuvwxy*z* fiffiffiffi
\$1234567890 .,-“:;!?

ABCDEFGHIJKLMN**OP**QRSTUVWXYZ&
*ABCDEFGHIJKLMN*OPQRSTUVWXYZ&
abcdefghijklmnopqrstuvwxy fiffiffiffiffi
\$1234567890 :;!?

Roman, Italic & SMALL CAPS Composition: 6, 7, 8, 9, 10, 11, 12 + accents

Roman Large Composition: 13, 14, 16, 18

DISPLAY: Roman: 14, 16, 18 (accents for 14, 18, 24, 30, 36)

Italic: 14, 16, 18, 24, 36, 48

Century School Book Bold #620

ABCDEFGHIJKLMN**OP**QRSTUVWXYZ&
abcdefghijklmnopqrstuvwxy fiffiffiffiffi
\$1234567890 .,-“:;!?

Roman Composition: 6, 8, 10, 11, 12

DISPLAY: Roman: 18, 24, 30, 36

Cheltenham Old Style #64

ABCDEFGHIJKLMN**OP**QRSTUVWXYZ&ÆŒ
abcdefghijklmnopqrstuvwxyæœ ctst fiffiffiffiffi
\$1234567890 .,-“:;!?"

*ABCDEFGHIJKLMN*OPQRSTUVWXYZ&ÆŒ
abcdefghijklmnopqrstuvwxyæœ fiffiffiffiffi
\$1234567890 .,-“:;!?"

Roman & Italic Composition: 6, 8, 10, 12

DISPLAY: Roman & Italic: 14, 18, 24, 30, 36

14 & 18 Roman and Italic accented characters

Cheltenham Old Style Bold #86

ABCDEFGHIJKLMNOPQRSTUVWXYZ&ÆŒ

abcdefghijklmnopqrstuvwxyzæœ fi fl ff fi fl

\$1234567890 .,-' :;!?

ABCDEFGHIJKLMNOPQRSTUVWXYZ&ÆŒ

abcdefghijklmnopqrstuvwxyzæœ fi fl ff fi fl

\$1234567890 .,-' :;!?

Roman Composition: 8, 9, 10, 12 Italic Composition: 8, 9, 12

DISPLAY: Roman & Italic: 14, 18, 24, 30, 36, 42, 48, 60, 72

Cheltenham Bold Condensed #88

ABCDEFGHIJKLMNOPQRSTUVWXYZ&ÆŒ

abcdefghijklmnopqrstuvwxyzæœ fi fl ff fi fl

\$1234567890 .,-' :;!?

A B C D E F G H I J K L M N O P Q

R S T U V W X Y Z & Æ Œ

a b c d e f g h i j k l m n o p q r s t u v w x y z

æ œ fi fl ff fi fl

\$ 1 2 3 4 5 6 7 8 9 0 .,-' :;!?

Roman & Italic Composition: 6, 8, 10, 12

DISPLAY: Roman: 14, 18, 24, 30, 36, 42, 48, 60, 72

Italic: 14, 18, 24, 30, 36, 60, 72

Cheltenham Bold Extended #287

A B C D E F G H I J K L M N O P Q R

S T U V W X Y Z & Æ Œ

a b c d e f g h i j k l m n o p q r s t u

v w x y z æ œ

\$ 1 2 3 4 5 6 7 8 9 0 .,-' :;!?

Roman Composition: 6

DISPLAY: Roman: 12, 14, 18, 24, 30, 36

Cheltenham-Bold Extra Cond #141

A B C D E F G H I J K L M N O P Q R S T

U V W X Y Z & Æ Œ

a b c d e f g h i j k l m n o p q r s t u v w

x y z æ œ fi ff fl

\$ 1 2 3 4 5 6 7 8 9 0 £ . , - ' : ; ! ?

DISPLAY: 14, 18, 24, 30, 36, 48, 60, 72

Cheltenham Bold Outline #12

CHARACTERS IN FONT

A B C D E F G H

I J K L M N O P

Q R S T U V W

X Y Z & Æ Œ £

\$ 1 2 3 4 5 6 7 8 9 0

a b c d e f g h i j

k l m n o p q r s

t u v w x y z æ œ

. , ; : - ' ! ?

fi ff fl

8 to 12 Point—82 Characters

14, 24, and 36 Point—80 Characters

18 and 30 Point—82 Characters

Roman Composition: 12 DISPLAY: Roman: 18, 30, 36

Cheltenham Old Style was designed by Bertram Goodhue in 1896 for D.B. Updike who was inspired by a Mr Kimball of teh Cheltenham Press in NY. M.F. Benton designed 18 variations at ATF from 1904-1911. The faces were popular and eventually marketed as a family to printers.

Cheltenham Bold Shaded #218

MONOTYPE SHADED TYPE FACES

**Cast brand new for every job, give
the job a sharp, clean-cut appearance**

DISPLAY: Roman: 12, 14, 18, 24, 30, 36

Cheltenham Old Style Condensed #264

A B C D E F G H I J K L M N O P Q R S T

U V W X Y Z & Qu

a b c d e f g h i j k l m n o p q r r s t u v w x y z

f i f f f f f l a s t \$ 1 2 3 4 5 6 7 8 9 0 . , - ' : ; ! ? ' "

DISPLAY: Roman: 14, 18, 24, 30, 36

Cheltenham Inline #286

CAN BE REDUCED

**The Monotype Does This Through
Its Non-Distribution System**

\$1234567890

DISPLAY: 24, 30, 36

Cheltenham Inline Extended #285

A B C D E F G H I J K L M N

O P Q R S T U V W X Y Z &

a b c d e f g h i j k l m n o

p q r s t u v w x y z

\$ 1 2 3 4 5 6 7 8 9 0 . , - ' : ; ! ?

DISPLAY: 18, 24, 30

Cheltenham Medium #186

ABCDEFGHIJKLMNOPQRSTUVWXYZ&ÆŒ

abcdefghijklmnopqrstuvwxyzæœ ffffffffl

\$1234567890 .,-“’;:;!?

ABCDEFGHIJKLMNOPQRSTUVWXYZ&ÆŒ

ABCDEFGHIJKLMNOPQRSTUVWXYZ&ÆŒ

abcdefghijklmnopqrstuvwxyzæœ ffffffffl

\$1234567890 .,-“’;:;!?

Roman Composition: 12

DISPLAY: Roman: 72, Italic: 36

Cheltenham Wide #164

ABCDEFGHIJKLMNOPQRSTUVWXYZ&ÆŒ

abcdefghijklmnopqrstuvwxyzæœctst ffffffffl

\$1234567890 .,-“’;:;!?"

ABCDEFGHIJKLMNOPQRSTUVWXYZ&ÆŒ

ABCDEFGHIJKLMNOPQRSTUVWXYZ&ÆŒ

abcdefghijklmnopqrstuvwxyzæœ ffffffffl

\$1234567890 .,-“’;:;!?

Roman & Italic Composition: 10, 12; Roman: 6

DISPLAY: Roman & Italic: 14, 18, 24, 30, 36

Cherokee, XenoType — see § Unique Faces

Chocolate type — see last page

Yes, edible type at long last !!!

Remington Typewriter 72L cast in 24 pt chocolate.

Linotype Slugs too !

Clearface #89 (Bold)

By M.F. Benton of ATF, first introduced in 1907.

A B C D E F G H I J K L M N O P Q R
S T U V W X Y Z & Æ Œ

a b c d e f g h i j k l m n o p q r s t u v w
x y z æ œ fi fl ff ffi ffl

\$ 1 2 3 4 5 6 7 8 9 0 £ . , - ' : ; ! ?

*A B C D E F G H I J K L M N O P Q R
S T U V W X Y Z &*

*a b c d e f g h i j k l m n o p q r s t u v
w x y z fi fl ff ffi ffl*

\$ 1 2 3 4 5 6 7 8 9 0 . , - ' : ; ! ?

Roman Composition: 6, 8, 10, 12

DISPLAY: Roman & Italic: 14, 18, 24, 30, 36

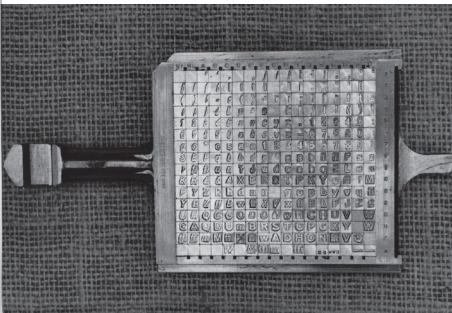

The typical matrix case includes five alphabets: roman caps, roman lower case, italic caps, italic lower case and small caps. Narrow characters occupy the top rows, wide characters the bottom rows. Sometimes not every character can be put into its appropriate row and must be cast separately or on a narrow body with a high space "underpin" to support the overhang. This is a 16x17 case.

Clearface Italic (Light) #2891

A B C D E F G
H I J K L M N
O P Q R S T U V
W X Y Z & \$ 1 2
3 4 5 6 7 8 9 0
a b c d e f g h i j
k l m n o p q r s t
u v w x y z ff fi fl
ffi ffl . , - ' : ; ! ?

DISPLAY, Italic: 14, 18

Cloister Black #95

1904 by J.W. Phinney, although also credited to M.F. Benton.

A B C D E F G H I J K L M N O P
Q R S T U V W X Y Z & Æ œ
a b c d e f g h i j k l m n o p q r s t u v w
x y z æ œ ð fi fl ff ffi ffl
\$ 1 2 3 4 5 6 7 8 9 0 £ . , = ' : ; ! ?

Roman Composition: 8, 12
DISPLAY: Roman: 14, 18, 24, 30, 36

COMPOSING MACHINES

The Matrix Case

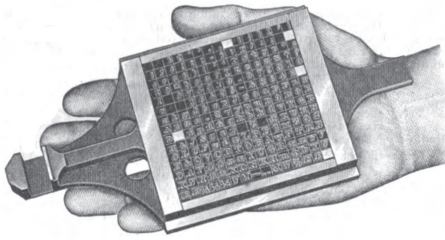

The Matrix Case, with its 225 individual matrices, is practically the heart of the Monotype, and, like the human heart, is vital to the successful use of the machine, though so small that it may be held in the hollow of one's hand.

The arrangement of the separate matrices in the Matrix Case is varied according to the character of the type face it contains: thus the machine is adjusted to the job and it is not necessary to change the job to suit the machine.

The Keyboard Arrangement

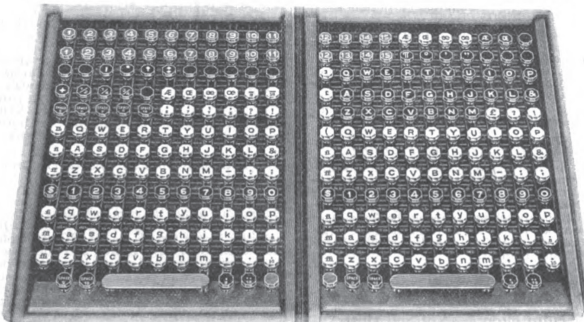

As will be seen by the engraving herewith, is arranged according to the universal typewriter layout, which has been proved by years of experiment and practical use to be the fastest arrangement possible, as well as the easiest for the operator.

The Monotype Keyboard is not changed when the Matrix Case arrangement is altered, but is adjusted by an intermediate part known as the keybar. Thus the speed of the operator is not reduced by an unfamiliar arrangement of the keys. This makes it possible for Monotype operators to acquire a very high speed by using the touch system.

Cloister Old Style was one of the early revival typefaces based on Venician Renaissance faces. Morris Benton based his on Jenson's roman type, c. 1897.

Cloister Bold #295

A B C D E F G H I J K L M N O P Q R R S

T U V W X Y Z & Qu

a b c d e f g h i j k l m n o p q r s t u v w x y z

fi fl ff ffi ffl &

\$ 1 2 3 4 5 6 7 8 9 0 . , - ' ' " " ; ; ! ?

A A B B C C D D E E F F G G H I J J K L M M

N N O P P Q R R S T T U V V W X Y Y Z & Qu

a b c d e f g h i j k l m n o p q r s t u v v w w

x y z fi fl ff ffi ffl & st

\$ 1 2 3 4 5 6 7 8 9 0 . , - ' ' " " ; ; ! ?

Roman & Italic Composition: 8, 10, 12

DISPLAY: Roman & Italic: 14, 18, 24, 30, 36, 42, 48, 60, 72

Cloister Old Style #395

A B C D E F G H I J K L M N O P Q R

R S T T U V W X Y Z &

a b c d e f g h i j k l m n o p q r s t u v

w x y z fi fl ff ffi ffl & Qu . , - ' ' " " ; ; ! ? () []

A B C D E F G H I J K L M N O P Q R S T U V W X

Y Z & \$ 1 2 3 4 5 6 7 8 9 0 \$ 1 2 3 4 5 6 7 8 9 0

A A B B C C D D E E F F G G H I J J K L M M N

N O P P Q R R S T T U V V W X Y Y Z &

a b c d e f g h i j k k l m n o p q r s t u v v w w x y z

fi fl ff ffi ffl & st Qu

\$ 1 2 3 4 5 6 7 8 9 0 . , - ' ' " " ; ; ! ? () [] \$ 1 2 3 4 5 6 7 8 9 0

DISPLAY: Roman & Italic: 14, 18, 24 Roman: 30, 36

SMALL CAPS: 14, 18 Swash: 14, 18

Cochin #61 aka *Sonderdruk*

Based on Peignot's 1912 version of Nicolas Cochin's engraved lettering of the 18th century, called *Moreau-Le-Jeune*. Monotype's version by Sol Hess c.1915.

ABCDEF GHIJKL MNOPQR STUVWXY Z&ÆŒ
abcdefghijklmnopqr stuvwxyzæœ fi fl ff ffi ffl
\$1234567890 .,-' : ; ! ?

ABCDEF GHIJKL MNOPQR STUVWXY Z&ÆŒ
ABCDEF GHIJKL MNOPQR STUVWXY Z&ÆŒ
abcdefghijklmnopqr stuvwxyzæœ fi fl ff ffi ffl
\$1234567890 ;! ? d e b n . p r s t f f

Roman, Italic & SMALL CAPS Composition: 6, 8, 10, 12
DISPLAY: Roman: 14, 18, 24, 30, 36
Italic: 14, 18, 24, 30, 36
Swash: 14

Cochin Bold #616 c. 1929, designed for Lanston Monotype by Hess.

A B C D E F G H I J K L M N O P Q
R S T U V W X Y Z & Æ Œ
a b c d e f g h i j k l m n o p q r s t u
v w x y z æ œ fi fl ff ffi ffl
\$ 1 2 3 4 5 6 7 8 9 0 . , - ' : ; ! ?

CHARACTERS IN FONTS

A B C D E F G H I J K L M N O
P Q R S T U V W X Y Z & Æ Œ
a b c d e f g h i j k l m n o p q r
s t u v w x y z æ œ ' s fi fl ff ffi ffl
\$ 1 2 3 4 5 6 7 8 9 0 . , - ' : ; ! ?

Standard C2 Arrangement
Composition -6 to 12 Point, 82 Characters. Display -14 to 36 Point, 82 Characters.

Roman Composition: 6, 8, 10, 12
DISPLAY: Roman: 14, 18, 24, 30, 36 Italic: 14, 18, 24, 30, 36

Cochin Open #262

A B C D E F G H I J K L M
N O P Q R S T U V W X Y Z &
a b c d e f g h i j k l m n o p q r
s t u v w x y z fi fl ff ffi ffl
\$ 1 2 3 4 5 6 7 8 9 0 . , - ' : ; ! ?

DISPLAY: 18, 24, 36

Cochin, Nicolas #461

A B C D E F G H I J K L M N O
P Q R S T U V W X Y Z &
a b c d e f g h i j k l m n o p q r s t u
v w x y z fi fl ff ffi ffl
\$ 1 2 3 4 5 6 7 8 9 0 . , - ' " : ; ! ? — « » * (

DISPLAY: Roman: 14, 18#2, 24, 36

Cochin, Nicholas Bold #105 (Baltotype copy of Peignot's font)

**A B C D E F G H I J K L M N O P Q
R S T U V W X Y Z & \$ 1 2 3 4 5 6 7 8 9 0
a b c d e f g h i j k l m n o p q r s t u v w x y z ! ? - , . ' ;**

DISPLAY: Roman: 18, 24, 30, 36, 48

Compressed No. 30, #108

ALL ROMAN, ITALIC AND BOLD FACES
On Standard Monotype Line for all Point Sizes from 5 to 12 Point Inclusive
can be cast to Line at One Operation
\$1234567890

DISPLAY: 6, 8, 10, 12, 14, 18

Comstock #202

SAVING THE DISTRIBUTION EXPENSE
Full Cases of New Type and Rule
Saves Distribution Expense, and
the Monotype Makes New Type
and Rule Cheaper than a
Compositor Can Distribute

DISPLAY: Roman: 12

The Giant caster makes type up to 72 points. In general the type is "cored" with one or two hollow areas inside the type body to save weight and metal. Spacing material as well as bars of material of any length can be cast also.

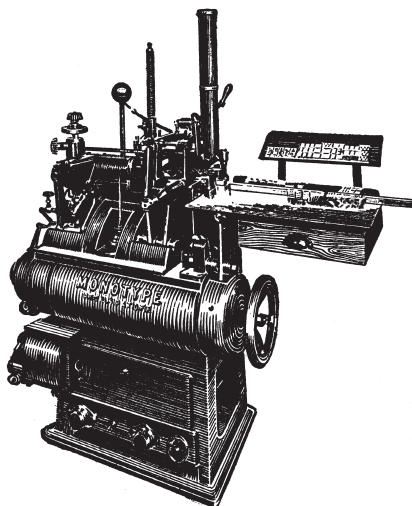

Cooper #482

Designed by Oswald B. Cooper for BB&S c. 1919-24.

A B C D E F G H I J K L M N
O P Q R S T U V W X Y Z &
a b c d e f g h i j k l m n o p q r s t u v w x y z
fi fl ff ffi ffl \$ 1 2 3 4 5 6 7 8 9 0 . , - ' : ; ! ?
· — & Q ~ [

Display — 8 to 18 Point, 83 Characters; 24 to 36 Point, 78

DISPLAY: Roman: 18, 24, 30, 36 Italic, 18, 24

Cooper Black #282

Designed by Oswald B. Cooper for BB&S c. 1921.

A B C D E F G H I J K L M N O P Q R S T
U V W X Y Z & · { Q —
a b c d e f g h i j k l m n o p q r s t
u v w x y z
\$ 1 2 3 4 5 6 7 8 9 0 . , - ' : ; ! ?

DISPLAY: 6, 8, 10, 12, 14, 18, 24, 30, 36, 42, 48, 60, 72

Cooper Tooled #582

A B C D E F G H I J K L M N
O P Q R S T U V W X Y Z &
a b c d e f g h i j k l m n
o p q r s t u v w x y z
\$ 1 2 3 4 5 6 7 8 9 0 £
· , - ' : ; ! ? — · Q [

DISPLAY: 24, 30, 36, 60

Copperplate Gothics- see Gothics
Corvinus - see Glamour

Cosmopolitan #4

Made in 1902 for the *Cosmopolitan* magazine,
later released by Monotype 1909-36.

ABCDEFGHIJKLMNOPQRSTUVWXYZ&Æ

abcdefghijklmnopqrstuvwxyzæ ß

\$1234567890 .,-' ;!?

ABCDEFGHIJKLMNOPQRSTUVWXYZ&Æ

ABCDEFGHIJKLMNOPQRSTUVWXYZ&Æ

abcdefghijklmnopqrstuvwxyzæ ß

\$1234567890 ;!?

Roman & SMALL CAPS Composition: 10

Craw Clarendon #65

The bracketed slab serifs made this distinctive style brought out by the Fann
St Foundry in England in 1845 very popular & widely copied. Designed by
Freeman Craw.

ABCDEFGHIJKLMNOPQRSTUVWXYZ&

abcdefghijklmnopqrstuvwxyz

\$1234567890 .,:;'!()-“”

Roman Composition: 7, 8, 9, 10

DISPLAY: Roman: 12, 14, 18, 24, 30, 36

Craw Clarendon Book #650

ABCDEFGHIJKLMNOPQRSTUVWXYZ&

abcdefghijklmnopqrstuvwxyz \$1234567890 .,:;'!()-% “”

Roman Composition: 7, 8, 9, 10

DISPLAY: Roman: 12, 14, 18, 24, 30, 36

Cushing Old Style #25

c. 1901 Lanston Monotype

A B C D E F G H I J K L M N O P Q R S

T U V W X Y Z & Æ Œ

a b c d e f g h i j k l m n o p q r s t u v w x y z

æ œ fi fl ff ffi ffl

\$1234567890 .,-“:;! ? \$1234567890

A B C D E F G H I J K L M N O P Q R S

T U V W X Y Z & Æ Œ

a b c d e f g h i j k l m n o p q r s t u v w x y z

æ œ fi fl ff ffi ffl

\$ 1 2 3 4 5 6 7 8 9 0 . , - ‘ ’ : ; ! ?

Roman & Italic Composition: 6, 7, 8, 9, 10, 11, 12 + accents

DISPLAY: Roman: 14, 18, 24, 30, 36 Italic: 14, 18, 24, 30, 36

Dante #592 (English Monotype)

Designed by Giovanni Mardersteig, released in 1959.,

cut by Charles Malin in 1954

ABCDEF GHIJKLMNOPQRSTUVWXYZ&ÆŒ

ABCDEF GHIJKLMNOPQRSTUVWXYZÆŒ

abcdefghijklmnopqrstuvwxyzfiflffffiffllæœ

ABCDEF GHIJKLMNOPQRSTUVWXYZ&ÆŒ

abcdefghijklmnopqrstuvwxyzfiflffffiffllæœ

1234567890 .,:;!?'-([†‡§ £\$*—\$§†])-'?!;,:. 1234567890

1234567890 F1276 ll 557 1234567890 F1373

Roman, Italic & SMALL CAPS Composition: 10, 11, 12, 13, Roman & Italic: 14, 16

Deepdene #315

By Goudy, c.1929-34

ABCDEFGHIJKLMNOPQRSTUVWXYZ&

abcdefghijklmnopqrstuvwxy z fffffffl

\$1234567890 .,-“”:;!?

ABCDEFGHIJKLMNOPQRSTUVWXYZ&

ABCDEFGHIJKLMNOPQRSTUVWXYZ&

A B C D E G M P T gy gg Æ

abcdefghijklmnopqrstuvwxy z fffffffl

\$1234567890 :;!?

Roman, Italic, SMALL CAPS Composition: 8, 10, 12

DISPLAY: Roman: 14, 16, 18, 24, 30, 36, 42, 48, 60, 72

DISPLAY ROMAN SMALL CAPS: 14, 16, 18

Italic: 14, 16, 24, 30, 36, 42, 48, 60, 72 Swash: 16, 24, 36

Deepdene Bold #317

ABCDEFGHIJKLMNOPQRSTUVWXYZ&

abcdefghijklmnopqrstuvwxy z fffffffl

\$1234567890 .,-“”:;!?

ABCDEFGHIJKLMNOPQRSTUVWXYZ&

abcdefghijklmnopqrstuvwxy z fffffffl

\$1234567890 .,-“”:;!?

DISPLAY: Roman: 42, 48, 60, 72

Italic: 42, 48, 60

Della Robbia #23 I

By Thomas Maitland Cleland for Lanston in 1902. The face was based on rubbings of inscriptions in Rome.

A B C D E F G H I J K L M N O P
Q R S T U V W X Y Z &
a b c d e f g h i j k l m n o p q r s t u
v w x y z fi fl ff ffi ffl
\$ 1 2 3 4 5 6 7 8 9 0 . , - ' : ; ! ?

Roman Composition: 6, 8, 10, 12
DISPLAY: Roman: 14, 18, 24, 30, 36

Delphian (Ludlow)

By R. Hunter Middleton for Ludlow c. 1928, and based on the Trajan Column.

A B C D E F G
H I J K L M N
O P Q R S T U
V W X Y Z &
\$ 1 2 3 4 5 6 7 8 9 0
◊ ◊ ◊ ◊ ◊ = ' ' ! ? =

Parenthesis are sold separately

()

Special DISPLAY casting: 36, 48

DeVenne #11 and italic #1111

Originally made in 1894 by Gustav Schroeder for the Central Type Foundry, later incorporated into the ATF, and named after T.L. DeVenne. aGoudy made a version in 1898. The origins of the design go to Romans produced in Europe.

A B C D E F G H I J K L M N
O P Q R S T U V W X Y Z & Æ Æ
a b c d e f g h i j k l m n o p q r s t u v w x y z
æ œ fi fl ff \$ 1 2 3 4 5 6 7 8 9 0 £ . , = ' : ; ! ?

*A B C D E F G H I J K L M N O P Q
R S T U V W X Y Z &
a b c d e f g h i j k l m n o p q r s t u
v w x y z \$ 1 2 3 4 5 6 7 8 9 0 . , = ' : ; ! ?*

Roman Composition: 12
DISPLAY: Roman: 14, 18, 24, 30, 36
Italic: 14, 18

DeVenne Condensed #111

A B C D E F G H I J K L M N O P Q R R S T U
V W X Y Z & Æ Æ
a b c d e f g h i j k l m n o p q r s t u v w x y z
fi fl ff æ œ
\$ 1 2 3 4 5 6 7 8 9 0 £ . , = ' : ; ! ?

DISPLAY: Roman: 14, 18, 24, 30, 36

DeVenne Outline #42

A B C D E F G H I J K L M N O
P Q R S T U V W X Y Z & Æ Æ
a b c d e f g h i j k l m n o p q r s t u v w x y z
æ œ fi fl ff \$ 1 2 3 4 5 6 7 8 9 0 £ . , = ' : ; ! ?

Roman Composition: 11
DISPLAY: Roman: 14, 18, 24, 30, 36

DeVenne Outline Italic #41

A B C D E F G H I J K L M N O
P Q R S T U V W X Y Z &
a b c d e f g h i j k l m n o p q r
s t u v w x y z
\$ 1 2 3 4 5 6 7 8 9 0 £ . , = ' : ; ! ?

DISPLAY: Italic: 14, 18, 30, 36

Doves (Proprietary)

No, you can't order this. Swamp engraved English Monotype style large composition matrices in the original 16 point size. Although not, strictly speaking, a facsimile of the original, it is almost indistinguishable from it. Due to the requirements of mechanical typesetting, the design had to be tweaked for the Monotype system, which means there are only certain set widths available, as opposed to foundry type wherein any set is possible.

The chart on the back of the case shows the layout of the matrices in their case, and below that and to the left the wedge, to the right the matrix case and in the foreground type produced from the mats.

Not wanting to upset the wonderful story of the Doves matrices and type tipped into the Thames river, the type will not be made available for general use. On our parts it was a proof of concept that large composition matrices could be made on the Benton. Also, we wanted Doves type for ourselves.

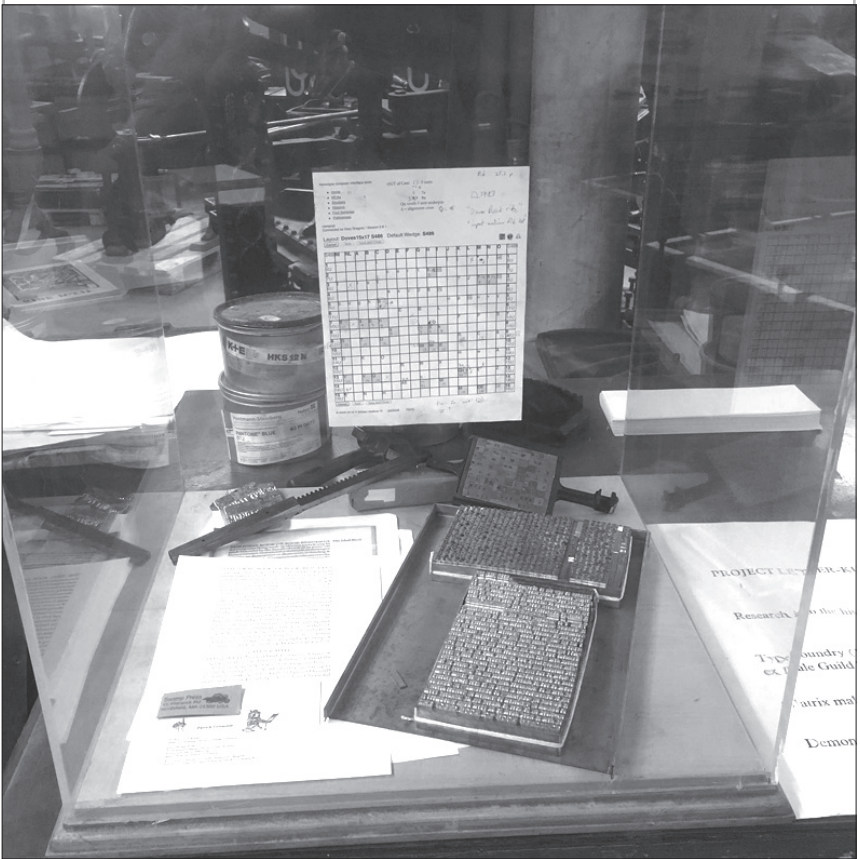

Draftsman Gothic— see Gothics

Eden Bold (Ludlow)

By R.H. Middleton c. 1934.

ABCDEFGHIJKLMN OPQRSTUVWXYZ
abcdefghijklmnopqrstu vwxyz.,:;!1234567890

DISPLAY: 24, 36, 48 (Special sorts casting)

Eden Light (Ludlow)

Characters in Complete Font

A B C D E F G H
I J K L M N O P
Q R S T U V W X
Y Z & \$
1 2 3 4 5 6 7 8 9 0
a b c d e f g h i j
k l m n o p q r s t
u v w x y z
. : , ; - ' ' ! ? — [] () ·

The per cent mark is sold separately

%

DISPLAY: 18, 24, 36, 48 (Special sorts casting)

Ehrhardt #453 (English Monotype)

SYNOPSIS IN 10 POINT

ABCDEFGHIJKLMNOPQRSTUVWXYZ&ÆĒ

ABCDEFGHIJKLMNOPQRSTUVWXYZÆĒ

abcdefghijklmnopqrstuvwxyzfiflffiffllæœ

ABCDEFGHIJKLMNOPQRSTUVWXYZ&ÆĒ

abcdefghijklmnopqrstuvwxyzfiflffiffllæœ

1234567890 .,:!?'-([†‡§£\$*—\$§†‡“?!;:, 1234567890

ALTERNATIVE CHARACTER AND FIGURES

1234567890 F1092 *h* 73 F1273 1234567890

Roman, Italic & Small Caps: 14 pt (14D)

Engravers Old English Bold #188

A B C D E F G H I J K L M N O P Q R S T U V W X Y Z &

abcdefghijklmnopqrstuvwxyz

\$ 1 2 3 4 5 6 7 8 9 0 .,-“:;!?

Roman Composition: 12

DISPLAY: 18, 24

Engravers Roman #223

Originally by ATF c. 1924.

A B C D E F G H I J K L M N O P Q R S T U V

W X Y Z &

\$ 1 2 3 4 5 6 7 8 9 0 .,- ‘ : ; ! ?

DISPLAY: 10, 12, 18, 24

Engravers Bold #323

A B C D E F G H I J K L M N O P Q R S T

U V W X Y Z &

\$ 1 2 3 4 5 6 7 8 9 0 .,- ‘ : ; ! ?

Roman Composition: 6, 8

DISPLAY: Roman: 14, 18, 24

Engravers Roman #347

CHARACTERS IN FONTS

ABCDEFGHIJKLMN OPQRSTUVWXYZ&

\$1234567890 .,-'";!?

ABCDEFGHIJKLMN OPQRSTUVWXYZ&

\$1234567890 .,-'";!?

ABCDEFGHIJKLMN OPQRSTUVWXYZ&

\$1234567890 .,-'";!?

ABCDEFGHIJKLMN OPQRSTUVWXYZ&

\$1234567890 .,-'";!?

Roman Composition: 6, Sizes 1-4

Engravers Text (Intertype)

INTERTYPE matrices excel in type design
and manufacturing methods w 12345

Special DISPLAY casting: 12, 14



The "large comp" matrix case is used to cast 14-24 point type. Due to larger matrices the roman and italic must run in separate cases. The caster must run slower in order to dissipate the heat generated by the larger volume of metal per cast.

Eusebius (Ludlow) aka Nicolas Jenson

By E.F. Dettterer, while R.H. Middleton did the other weights. c. 1924, and based on Jenson's type.

Characters in Complete Font

A B C D E F G H I J
K L M N O P Q R S T
U V W X Y Z & \$ 1 2
3 4 5 6 7 8 9 0 a b c d
e f g h i j k l m n o p q r s
t u v w x y z ff fi ffi fl ffl
. : , ; - ' ' ! ? () -

Supplementary Ligatures

QU Qu f ff fa ffa fe ffe
ffn fo ffo fr ffr fs ffs ft
fu ffu fy et st []

Oldstyle Figures

1 2 3 4 5 6 7 8 9 0

When ordering fonts specify either
Modern or Oldstyle figures

%

The per cent mark is sold separately

Characters in Complete Font

*A B C D E F G H I J K L
M N O P Q R S T U V W
X Y Z & \$ 1 2 3 4 5 6 7 8 9 0
a b c d e f g h i j k l m n o
p q r s t u v w x y z ff fi ffi fl ffl
. : , ; - ' ' ! ? () -*

Characters listed below sold separately
Available in sizes 12 point to 72 point

*A B C D E G L M
N P R Y Th e g k
n r z*

Following characters available in all sizes

*\$ 1 2 3 4 5 6 7 8 9 0
QU Qu et st [] %*

PROBLEM OF SORTS Banished in Ludlow plants

Special Display casting Ludlow: Roman: 8^{sc}, 10^{sc}, 12^{sc}, 16^{sc}, 18^{sc}, 24, 36

Italic: 8^{sc}, 10^{sc}, 12^{sc}, 16^{sc}, 18^{sc}, 36^{sc}, 48^{sc}

Eusebius Open (Ludlow)

Characters in Complete Font

A B C D E F G H I
J K L M N O P Q
R S T U V W X Y
Z & \$ 1 2 3 4 5 6
7 8 9 0 a b c d e f g h i
j k l m n o p q r s t u
v w x y z ff fi ffi fl ffl
. : , ; ' ' ! ? () —

Oldstyle Figures

1 2 3 4 5 6 7 8 9 0

Supplementary Characters

Qu QU f ff fa ffa fe ffe
fo ffo ffn fr ffr fs ffs ft
fu ffu fy ct st []

Modern or oldstyle figures should be specified when ordering matrices. Fonts are available with or without supplementary characters and either supplementary characters or oldstyle figures can be supplied separately.

‰

The per cent mark is made for all sizes

Eusebius Open

Special Ludlow Display casting: 18, 24, 36^{sc} 48^{sc}

Fabritius (English Monotype) #586

ABCDEFGHIJKLMN OPQRSTUVWXYZ & Æ Œ

ABCDEFGHIJKLMN OPQRSTUVWXYZ Æ Œ

abcdefghijklmnopqrstu vwxyz f i f f f f f f f f æ œ

1234567890 .,:;!?"'-(+§-

Roman + Small Caps Composition: 14 Didot (on 16 pt English body)

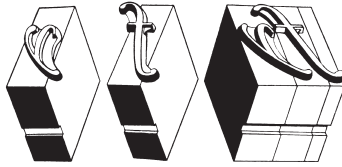

Kerned Type. The “kern” is the overhanging part of the letter— in this case the tail of the “y” and the head and tail of the “f” character. The ability to cast type with kerns is not possible with regular Linotype or Intertype matrices, and represents one of the fundamentally superior aspects of Monotype and foundry type. The kerns are fragile, having no support underneath them to withstand the impact of letterpress printing. However if there is another character alongside the kerned type the kern is supported by the neighbor’s body, as shown above.

Also note the use of a “high space” to the right of the “f” character. This technique should be used whenever there is no supporting character alongside. It is important to make sure the underside of the kern and the top of the adjacent body or high space are clean and free of flashed metal or dirt so that the kern seats nicely and does not get bent upwards, which can result in inking and impression problems as well as increasing the likelihood of breaking the kerned portion off.

Fairfield (Light) (Linotype)

By Rudolph Ruzicka c. 1939-1949.

Special casting (Linotype): Roman, Italic, Scaps, accents (lining figs)

12 & 14 pt (12 Δ 508, 14 Δ 282)

ABCDEFGHIJKLMNOPQRSTUVWXYZ&
ABCDEFGHIJKLMNOPQRSTUVWXYZ&

ABCDEFGHIJKLMNOPQRSTUVWXYZ

12345 abcdefghijklmnopqrstuvwxyz 67890

VBCDE abcdefghijklmnopqrstuvwxyz FGRT0

, . : ; ? ! (|) * ' ' - - Z Æ Œ Þ & £ \$. . . fi fl ff ffi ffl
, . s ; ? ! A I Q O ' ' - - u Æ Œ Þ N £ P L . . . fi Y ff W M

Farmer's Old Style #15

ABCDEFGHIJKLMNOPQRSTUVWXYZ&ÆŒ

abcdefghijklmnopqrstuvwxyzæœ fififfiffi

\$1234567890 .,-':;!/? \$1234567890

ABCDEFGHIJKLMNOPQRSTUVWXYZ&ÆŒ

ABCDEFGHIJKLMNOPQRSTUVWXYZ&ÆŒ

abcdefghijklmnopqrstuvwxyzæœ fififfiffi

\$1234567890 :;!/? \$1234567890

Composition: Roman: 6,12; Roman, Italic & SMALL CAPS: 7, 8, 11

Flash and Flash Bold, see Scripts

Florentine Series no. 1

.....
Skulls & Crossbones
.....

Based on inlaid marble floor tomb slabs in the nave
of Santa Croce, Florence, Italy. \$15.00

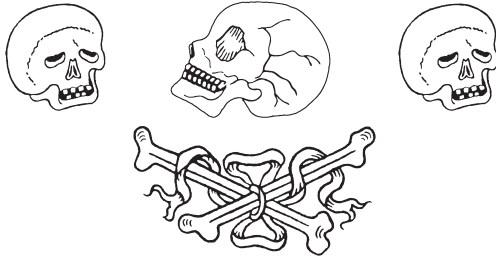

3 each of two skulls, 3 small & 2 large crossbones

(Skulls are 36 pt, crossbones 30 & 36 pt)

Renaissance designs by Ed Rayher based on trips to Italy

Forum Initials #274

By Goudy and shown in 1912, Lanston c. 1924,

ABCDEFGHIJKLMN
OPQRSTUVWXYZ\$0
1234567890.,:;!?- (

DISPLAY: 12, 14, 18, 24, 30, 36

Fournier Le Jeune #305

Deberny & Peignot design based on PS. Fournier's 1746 decorative letters,
c. 1913.

A B C D E F
G H I J K L
M N O P Q R
S T U V W X
Y Z &
\$ 1 2 3 4 5 6
7 8 9 0
. , - ' ! ?

DISPLAY: 18, 24, 30

French Cadmus #22

ABCDEF GHI JKLMNOPQRSTUVWXYZ&ÆŒ
abcdefghijklmnopqrstu vwxyzæœ fiffiffiffi
\$1234567890 .,-' ;!?
ABCDEF GHI JKLMNOPQRSTUVWXYZ&ÆŒ
ABCDEF GHI JKLMNOPQRSTUVWXYZ&ÆŒ
abcdefghijklmnopqrstu vwxyzæœ fiffiffiffi
\$1234567890 ;!?

Roman, Italic & SMALL CAPS Composition: 8, 9, 10; Roman & SMALL CAPS: 12

French Old Style No. 552, #71

c. 1908 similar to DeVinnie.

ABCDEFGHIJKLMNOPQRSTUVWXYZ&ÆŒ
abcdefghijklmnopqrstuvwxyzæœ fi fl ff ffi ffl
\$1234567890 .,-“:;!?

ABCDEFGHIJKLMNOPQRSTUVWXYZ&ÆŒ
ABCDEFGHIJKLMNOPQRSTUVWXYZ&ÆŒ
abcdefghijklmnopqrstuvwxyzæœ fiftffffiff
\$1234567890 :;!?

Roman & Italic Composition: 10, 12

DISPLAY: Roman: 14, 18, 24, 30, 36

French Round Face #150

c. 1906 similar to DeVinnie...

ABCDEFGHIJKLMNOPQRSTUVWXYZ&ÆŒ
abcdefghijklmnopqrstuvwxyzæœ fiftffffiff
\$1234567890 .,-“:;!?

ABCDEFGHIJKLMNOPQRSTUVWXYZ&ÆŒ
ABCDEFGHIJKLMNOPQRSTUVWXYZ&ÆŒ
abcdefghijklmnopqrstuvwxyzæœ fiftffffiff
\$1234567890 :;!?

Roman, Italic & SMALL CAPS Composition: 8, 10, 12, Roman: 6

DISPLAY: Roman: 14, 18, 24, 30, 36 Italic: 18, 24, 30, 36

Futura— see Twentieth Century — § Sans Serifs

Gaelic: see Unique Faces section at end

Friedlander Initials by Swamp Press

A special engraving project with Incline Press in England. Graham Moss kindly shared images of these initials by Elizabeth Friedlander which were drawn for a book on Churchill. This is the first rendering into hot metal, ever.

Friedlander designed fonts such as *Elizabeth*, but had to flee Nazi persecution and wound up in England, designing books, and eventually ornaments for Monotype.

Initials are cast on 42 pt except the J, which is cast on 48 pt body.



Gallia #313

c. 1928 Lanston Monotype.

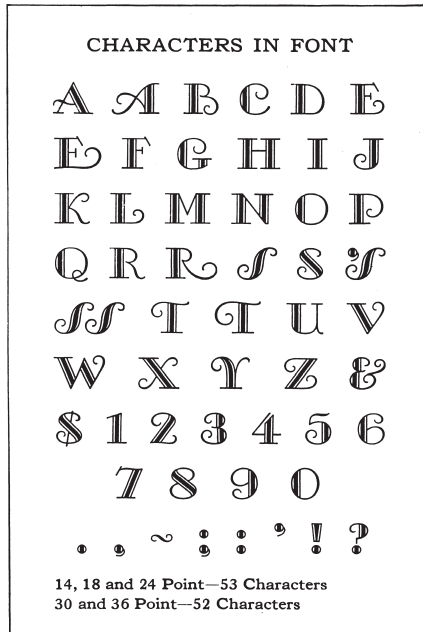

DISPLAY: 14, 18, 24, 30, 36, 60

Garamond (English Monotype) #156

Released in 1922 and based on Jannon's c. 1620 roman, the italic based on Robert Granjon's c. 1550 cuttings. The "Original Garamond" font introduced at the Paris World's Fair in 1900 started a rush to bring out updated Garamond faces.

ABCDEFGHIJKLMNOPQRSTUVWXYZ&ÆŒ

ABCDEFGHIJKLMNOPQRSTUVWXYZ&ÆŒ

abcdefghijklmnopqrstuvwxyzfiflffiffllæœ

ABCDEFGHIJKLMNOPQRSTUVWXYZ&ÆŒ

abcdefghijklmnopqrstuvwxyzfiflffiffllæœ

1234567890 .,:;!?"-([†‡§£\$*—\$'?!;:, 1234567890

ALTERNATIVE CHARACTERS AND FIGURES

1234567890 F214 h 75 J 669 z 144 F341 1234567890

Large Roman & Italic Composition: 14, 18, 24

Swash: 14 (not complete)

A B C D E E x F G H J K M N a N e N i N o N u P Q U Qu Qu R e R e R i R o R u T V
as d e et fr q, gg gj gy ij is k, ky ll m n L s f b st tt ta us v zy f a f b f c f e f h f i f k f l f o f s f t f u f v f w f x f y f z f a f f e f f i f f l f f o f f u

Swash and ligatured characters are also available in composition sizes. Not all characters are available in every size

Garamont #248 (1921 Goudy based on Jannon (1615) & Granjon)

ABCDEFGHIJKLMNOPQRSTUVWXYZ&ÆŒ

abcdefghijklmnopqrstuvwxyzæœ fiflffiffll

\$1234567890 ., - ' : ; ! ? [] () Q U u \$ I 1234567890 £

ABCDEFGHIJKLMNOPQRSTUVWXYZ&ÆŒ

ABCDEFGHIJKLMNOPQRSTUVWXYZ&ÆŒ

abcdefghijklmnopqrstuvwxyzæœ fiflffiffll

\$1234567890 :;! ? Q U u et st \$1234567890

Roman, Italic & SMALL CAPS Composition: 6,8,9,10,11,12 + accents;

Roman Large Composition: 14, 18

DISPLAY: Roman: 14, 18, 24, 30, 36, 42, 48

Italic: 14, 18, 24, 30, 36, 42, 48, 60, 72

Swash: 12, 14, 18, 24, 30, 36

SMALL CAPS: 14, 18

Garamond Bold #548

ABCDEFGHIJKLMNOPQRSTUVWXYZ&

abcdefghijklmnopqrstuvwxy^z fiffiffiffi

\$1234567890 .,-'";!?\$1234567890

ABCDEFGHIJKLMNOPQRSTUVWXYZ&

A B C D E G L M N P R T Y &

abcdefghijklmnopqrstuvwxy^z

a e m n t a s c t f r g y h i s k k e l l s p s t t u s v w f i f l f f f i f f l

\$1234567890 .,-'";!?\$1234567890

Roman, Italic, Small Caps Composition: 6, 7, 8, 9, 10, 11, 12 + accents + swash

DISPLAY: Roman: 14, 18, 24, 30, 36, 42, 48, 60, 72

Italic: 14, 18, 24, 30, 36, 42, 48, 60, 72 Swash: 14, 24

Garamond, American #648

ABCDEFGHIJKLMNOPQRSTUVWXYZ&

abcdefghijklmnopqrstuvwxy^z fiffiffiffiffi&st

\$1234567890 .,-'";!?\$1234567890

ABCDEFGHIJKLMNOPQRSTUVWXYZ&

ABCDEFGHIJKLMNOPQRSTUVWXYZ&

abcdefghijklmnopqrstuvwxy^z fiffiffiffiffi&st

\$1234567890 .,-'";!?\$1234567890

a s f r g y i s l l s p t t u s

Roman, Italic & SMALL CAPS Composition: 6, 7, 8, 9, 10, 11, 12

Gill Sans, see Sans Serif Section

Glamour Light (Corvinus) #235

By Imre Reiner for Bauer, c. 1929-34.

ABCDEFGHIJKLMNOPQRSTUVWXYZ&
abcdefghijklmnopqrstuvwxyz \$1234567890 .,:;! ? () * + " "

DISPLAY: Roman: 48

*ABCDEFGHIJKLMNOPQRSTUVWXYZ&
NOPQRSTUVWXYZ&
abcdefghijklmnopqrstuvwxyz
\$1234567890*

Display Italic: 30, 48

Glamour Medium #236

ABCDEFGHIJKLMNOPQRSTUVWXYZ&
abcdefghijklmnopqrstuvwxyz \$1234567890 .,:;! ? () - * " " + €

*ABCDEFGHIJKLMNOPQRSTUVWXYZ&
abcdefghijklmnopqrstuvwxyz \$1234567890 .,:;! ? () - * " " + €*

DISPLAY: Roman: 14, 18, 24, 30, 36, 48

Italic: 14, 16, 18, 24, 30, 48

Glamour Bold #237

**A B C D E F G H I J K L M N O P Q
Q R S T U V W X Y Z &
a b c d e f g h i j k l m n o p q r s t u
v w x y z fi fl ff ffi ffl ft
\$12334567890 ., - ' " " : ; ! ? * + (€ %**

DISPLAY: Roman: 14, 18, 24, 30, 36

Glamour Condensed (Corvinus Skyline) no number

ABCDEFGHIJKLMNOPQRSTUVWXYZ&
abcdefghijklmnopqrstuvwxyz fffifl
\$1234567890 .,:;!()*“” (†

DISPAY: Roman: 12, 16, 18, 24, 30, 36, 48, 60, 72

Gothics — see Gothics! — § III

Goudy Cursive #324

These swash characters combine with Goudy Old Style italic #3941

A B C D E F G H I K L M N
O P R S T U W X Y Z Œ QU
e g k m n r v w x Qu Th st s ~ ~ ~

DISPLAY: 14, 18, 24, 30, 36

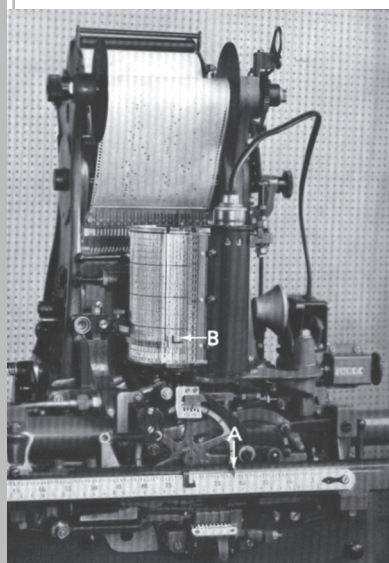

The “tower” of the keyboard. By typing the text a paper ribbon similar to a piano roll is punched with the coordinates of the characters in the composition matrix case. The keyboard calculates the spacing mechanically so that justification may be performed, as well as centering, letter-spacing, etc. Fonts can be keyboarded so that they can be cast “automatically” on the comp caster.

Goudy Hand Tooled #383

A B C D E F G H I J K L M N O P Q

R S T U V W X Y Z &

a b c d e f g h i j k l m n o p q r s t u v

w x y z fi fl ff ffi ffl

\$ 1 2 3 4 5 6 7 8 9 0 £ . , - ' : ; ! ?

DISPLAY: Roman: 14, 18, 24, 30, 36, 42, 48, 60, 72

A B C D E F G H I J J

K L L M M N N O O P P Q Q R R S

S T T U U V V W W X Y Y Z Z &

a a b c d e e f g h i j k k l m m n n o p

q r s t L u v v w w x y z & fi fl ff ffi ffl

\$ 1 2 3 4 5 6 7 8 9 0 . , - ' ' : ; ! ?



DISPLAY: Italic: 14, 18, 24, 30, 36, 42, 48, 60, 72

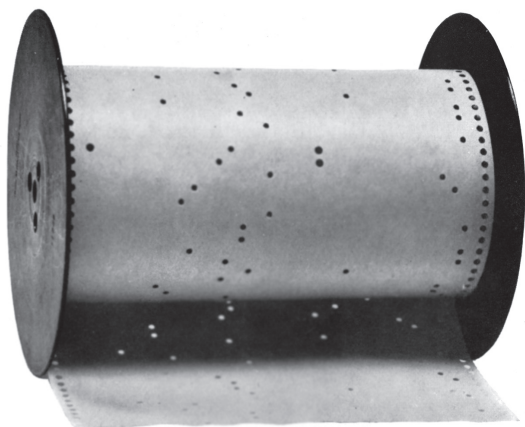

A spool of keyboard ribbon. Note the perforations. Now obsolete.

Goudy Heavyface #380 (c. 1926)

A B C D E F G H I J K L M N O P Q R S

T U V W X Y Z & & . © Qu

a b c d e f g h i j k l m n o p q r s t u v

w x y z fi fl ff ffi ffl th ct st

1 2 3 4 5 6 7 8 9 0 \$ 1 2 3 4 5 6 7 8 9 0

., - ' : ; ! ? [] ¶ ∞ − ∞ ∞ & † † †

A B C C D E F G H I J K L M M N

O P P Q R S T & U V U W X Y Z &

a b c d e f g g h i j k l m n o p q r s t

u v w x y z fi fl ff ffi ffl

The t he an d of

\$ 1 2 3 4 5 6 7 8 9 0 . , - ' : ; ! ?

DISPLAY: Roman: 14, 18, 24, 30, 36, 72 Italic: 14, 18, 24, 30, 36, 42, 48, 60, 72

Goudy Heavyface Open # 391

GOOD NEWS A Heavyface open \$1234

DISPLAY: Roman: 36

Goudy Lanston # 279

CHARACTERS IN FONTS

A B C D E F G H I J K L M N O P Q R
S T U V W X Y Z &
a b c d e f g h i j k l m n o p q r s t u v w x
y z æ œ ã fi fl ff ffi ffl
\$ 1 2 3 4 5 6 7 8 9 0 . , ' : ; ! ? ı 2 3 4 5 6 7 8 9 0

Display -14 to 36 Point, 80 Characters.

(Lining Figures supplied with all Fonts unless Hanging Figures are specified.)

DISPLAY: Roman: 18, 24, 30, 36

Goudy Modern #293

c. 1918 by Frederick Goudy for Lanston Monotype.

A B C D E F G H I J K L M N O P Q
R S T U V W X Y Z &
a b c d e f g h i j k l m n o p q r s t u v w x y z
fi fl ff ffi ffl \$ ı 2 3 4 5 6 7 8 9 0 . , ' : ; ! ?

A B C D E F G H I J K L M N O P Q
R S T U V W X Y Z &
a b c d e f g h i j k l m n o p q r r s t u v w x y z
fi fl ff ffi ffl \$ ı 2 3 4 5 6 7 8 9 0 . , ' : ; ! ?

DISPLAY: Roman: 12, 14, 18, 24, 30, 36

Italic: 18, 24, 30, 36

Goudy Old Style #394

c. 1930, originally done for ATF (1915-16).

ABCDEFGHIJKLMNOPQRSTUVWXYZ&

abcdefghijklmnopqrstuvwxy^z *fi*flffiffillet

\$1234567890 .,-“:;!?”^Œ

ABCDEFGHIJKLMNOPQRSTUVWXYZ&

ABCDEFGHIJKLMNOPQRSTUVWXYZ&

abcdefghijklmnopqrstuvwxy^z *fi*flffiffillet

\$1234567890 “:;!?” *G J T Y*

Roman, Italic & SMALL CAPS Composition: 6, 8, 10, 12 + accents

Goudy Old Style #291 (English Monotype) Roman small composition: 14 (14D)

DISPLAY #394: Roman & Italic : 14, 18, 24, 30, 36

Roman: 42, 48

SMALL CAPS: 14, 18

(“D” stands for “Didot” the European point system based on one pica measuring 0.1776 inches versus the English or American pica being 0.1660 inches, although both picas consist of 12 points.)

Type & Spacing

(a) em quad (b) type (c) 2 em quad (d) en space (e) regular space:

“3 to em” or “thick space” (f) middle space: 4 to em (g) thin space

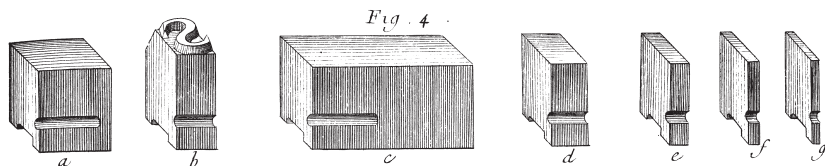

Goudy Old Style Light #38

ABCDEFGHIJKLMNOPQRSTUVWXYZ&ÆŒ

abcdefghijklmnopqrstuvwxyzaeæ fiffiffiffi

\$1234567890 .,:;'! \$1234567890

ABCDEFGHIJKLMNOPQRSTUVWXYZ&ÆŒ

ABCDEFGHIJKLMNOPQRSTUVWXYZ&ÆŒ

abcdefghijklmnopqrstuvwxyzaeæ fiffiffiffi

\$1234567890 :;! \$1234567890

Standard C Arrangement

(Roman, Small Caps and Italic can be combined for Machine Typesetting
in the sizes shown.)

Long Descenders in 10 and 11 Point:

JQ g j p q y J 3 4 5 7 9 J Q f g j p q y fi fl ff ffi ffl 3 4 5 7 9

Long Descenders in 12 Point (2 x 4 matrices):

g j p q y f g j p q y fi fl ff ffi ffl

Roman, Italic & SMALL CAPS Composition: 6, 8, 9, 10, 12

DISPLAY: Roman & Italic: 14, 18, 24, 30, 36

Goudy Bold #294

ABCDEFGHIJKLMNOPQRSTUVWXYZ&

abcdefghijklmnopqrstuvwxyzaeæ fiffiffiffi

\$1234567890 .,:;'!()

ABCDEFGHIJKLMNOPQRSTUVWXYZ&

abcdefghijklmnopqrstuvwxyzaeæ fiffiffiffi

\$1234567890 .,:;'!()

Roman & Italic Composition: 6, 8, 10, 12

DISPLAY: Roman & Italic: 14, 18, 24, 30, 36, 42, 48, 60, 72

Swash: 18, 24, 30, 36

Goudy Open #291

A B C D E F G H I J K L M N O P

Q R S T U V W X Y Z &

a b c d e f g h i j k l m n o p q r s

t u v w x y z fi fl ff ffi ffl

\$ 1 2 3 4 5 6 7 8 9 0 . , - ' : ; ! ?

A B C D E F G H I J K L M N O P Q R

S T U V W X Y Z &

a b c d e f g h i j k l m n o p p q r r s t u

v w x y z fi fl ff ffi ffl

\$ 1 2 3 4 5 6 7 8 9 0 . , - ' : ; ! ? ¶

DISPLAY: Roman: 14, 18, 24, 30, 36

Italic: 14, 18, 24, 30, 36

Goudy Text #327

A B C D E F G H I J K L M N O P Q R S T U V W X Y Z &

a b c d e f g h i j k l m n o p q r s t u v w x y z æ fi fl ffi ffl

\$ 1 2 3 4 5 6 7 8 9 0 . , - ' : ; ! ?

DISPLAY: Roman: 14, 18, 24, 30, 36, 48

Granby, see Sans Serif Section

Grasset #117

By Eugène Grasset for Deberny & Peignot c. 1898

abcdefghijklmnopqrstuvwxy
z
ABCDEFGHIJKLMN
OPQRSTUVWXYZ
\$1234567890

abcdefghijklmnopqrstuvwxy
*ABCDEFGHIJKLMN
OPQRSTUVWXYZ*
\$1234567890

Roman & Italic Composition: 8, 10, 12

Greco Bold #326

c. 1925 aka Bristol.

**ABCDEFGHIJKLMN
OPQRSTUVWXYZ&
abcdefghijklmnopqrstuvwxy \$1234567890 .,:;!?'()**

DISPLAY: Roman 12, 14, 18, 24, 30, 36

Greek, Porson #155 — See Foreign Faces

Greeting Monotone — see Scripts

Grotesques — see Sans Serifs & Scripts

Half Title #905

**ABCDEFGHIJKLMN
OPQRSTU
VWXYZ&ÆŒ\$£0123456789æff
œffiffiffiabcdefghijklmnopqrst
uvwxyz.,:;!?'-**

DISPLAY: 14 + accents

Hebrew — see Foreign Faces

Hadriano Titling #309

By Goudy in 1918 for Continental Typefounders Association after an inscription in the Louvre. Monotype version 1929.

A B C D E F G H I J K L M N
O P Q R S T U V W X Y Z . ,
1 2 3 4 5 6 7 8 9 0 &

FWG SAYS: THE OLD
FELLOWS STOLE ALL

DISPLAY: Roman: 12, 18, 24, 30, 36

Hess Bold (Goudy Bold Face) #159 (1910 by Sol Hess)

A B C D E F G H I J K L M N O P Q
R S T U V W X Y Z & Æ Æ
a b c d e f g h i j k l m n o p q r s t u
v w x y z æ œ fi fl ff ffi ffl
\$ 1 2 3 4 5 6 7 8 9 0 . , - ' : ; ! ?

*A B C D E F G H I J K L M N O P Q
R S T U V W X Y Z &
a b c d e f g h i j k l m n o p q r s t u
v w x y z fi fl ff ffi ffl
\$ 1 2 3 4 5 6 7 8 9 0 . , - ' : ; ! ?*

Roman Composition: 6, 10, 12

DISPLAY: Roman: 14, 18, 24, 30, 36 Italic: 14, 30, 36

Hess Neobold # 363

(1933 by Sol Hess)

Fonts Contain 46 Characters—Available in 36 Point only

A B C D E F G H I J K L M N O
P Q R S T U V W X Y Z &
\$ 1 2 3 4 5 6 7 8 9 0 . , - : ; ' ! ?

Roman: 36H4 (only size made)

Hess Old Style #242

(1920-23, based on Jenson)

A B C D E F G H I J K L M N O P Q R S T U V W X Y Z & Æ Æ
abcdefghijklmnopqrstuvwxyzæœ fiflfffffl
\$ 1 2 3 4 5 6 7 8 9 0 . , - ' : ; ! ?

A B C D E F G H I J K L M N O P Q R S T U V W X Y Z & Æ Æ
A B C D E F G H I J K L M N O P Q R S T U V W X Y Z & Æ Æ
abcdefghijklmnopqrstuvwxyzæœ fiflfffffl
\$ 1 2 3 4 5 6 7 8 9 0 ; : ! ?

Roman, Italic, SMALL CAPS Composition: 6, 8, 9, 10, 12 + accents
DISPLAY: Roman & Italic : 14, 18, 24, 30, 36

Hess Title (Hess Bold Face) #161

ABCDEFGHIJKLMNOPQRSTUVWXYZ&ÆŒ

abcdefghijklmnopqrstuvwxyæœ fiffiffiffi

\$1234567890 .,-“:;!?

ABCDEFGHIJKLMNOPQRSTUVWXYZ&ÆŒ

abcdefghijklmnopqrstuvwxyæœ fiffiffiffi

\$1234567890 .,-“:;!?

Roman Composition: 10
DISPLAY: Roman: 14, 18, 24, 30, 36

Howland #139

abcdefghijklmnopqrstuvwxy

ABCDEFGHIJKLMNOPQRSTUVWXYZ

\$1234567890

OUR MONOTYPE MATRIX

Will Cast Figures as Large as 36 Point
and in Justified Lines

\$1234567890

DISPLAY: Roman: 24, 30, 36

Howland Open #96

“PRINTING FOR PROFIT”

Is Our Answer to that Interesting Query, “What
is the Matter with the Printing Business?”

\$1234567890

DISPLAY: Roman: 18, 24, 30, 36

Hungry Dutch by Russell Maret

IN A GROUND-BREAKING PROJECT Russell Maret designed this new type face in collaboration with the Type Archive in London and produced the first new Monotype composition face since the 1970's. Although most people thought this was an impossible quest, as the many departments of Monotype that used to be needed to bring a design through the steps of making patterns, engraving punches and then punching and finishing the matrices were long gone, Russell and the Archive pulled feat this off.

12 pt. fonts at \$70 (half strength 16A36a) & composition are now available from Swamp Press.

A B C D E F G H I J K L M N O

P Q R S T U V W X Y &

a b c d e f g h i j k l m n o p q r

s t u v w x y z fi ff fl ffi ffl ct st

. , : ; ' ' () [] ? ! - —

1 2 3 4 5 6 7 8 9 0 \$

Imprint #101 (English)

Designed by Gerald Meynell, J.H. Mason and Edwrad Johnson and based on Caslon Old Style. The first face to be cut specifically for mechanical composition and cut for use in *The Inprint* magazine. c. 1913

When jobs have their
type sizes fixed quickly
ABCDEFGHIJKLMN
OPQRSTUVWXYZ

Roman, Italic & Small caps Composition: 8, 10
DISPLAY: Roman: 18

Ionic #62

Caslon did the first version in 1842, similar to a Clarendon. c. 1925

**FACES OF THIS DESIGN
Excepting The Lightest Of
weights are durable, having**

Roman Composition: 7
DISPLAY: 18, 30, 36
Greek Characters only 24 pt.

Ionic / Lining Gothic No.525, #56

ABCDEFGHIJKLMN OPQRSTUVWXYZ Æ & Æ
abcdefghijklmnopqrstuvwxyz æ œ f i f f f i f f i

.,:;-“!?” \$1234567890

Roman Composition: 5.5, 6, 8

Ionic, Round (Inland) #156

THIS DESIGN BELONGS TO THE ANTIQUE VARIETY OF Letters Used Extensively In America During The Latter Half of the Nineteenth Century. These types, with their usually thick and durable lines, were a natural reaction against the thin, delicate romans much in vogue prior to their time. The lower case is larger in proportion to the height of the capitals

Roman Composition: 6

Italian Old Style #243

aka Jenson. By Joseph W. Phinney for ATF. Goudy reworked things modelling on the Veronese types.

A B C D E F G H I J K L M N O P Q R
S T U V W X Y Z &

a b c d e f g h i j k l m n o p q r s t u v w x y z
æ st P Q fi fl ffi ffl ., - ' : ; ! ?

\$ 1 2 3 4 5 6 7 8 9 0 or \$ 1 2 3 4 5 6 7 8 9 0

A B C C D E E F G H I J K L L M N

O P Q Q R S T T U V U W X Y Z &

a b c d e f g h i j k l m n o p q r s t u v w

x y z æ st P fi fl ffi ffl ., - ' : ; ! ?

\$ 1 2 3 4 5 6 7 8 9 0

Composition: Roman & Italic: 8; Roman, Italic and SMALL CAPS: 10, 12
DISPLAY: Roman & Italic : 14, 18, 24, 30, 36

Italian Old Style Wide #443

A B C D E F G H I J K L M N O
P Q R S T U V W X Y Z & Æ Æ
a b c d e f g h i j k l m n o p q r s
t u v w x y z æ œ st ct fi fl ff ffi ffl
\$ 1 2 3 4 5 6 7 8 9 0 . , - ' : ; ! ? ¶

Display – 14 to 36 Point, 84 Characters

DISPLAY: Roman: 14, 18, 24, 30, 36

Janson #401

Based on 1690 type by Nicolas Kis, a Hungarian in AMsterdam. Stemple had the original mats since 1919. The face is not based on Janson's type.

A B C D E F G H I J K L M N O P Q
R S T U V W X Y Z &
a b c d e f g h i j k l m n o p q r s t u
v w x y z fi fl ff ffi ffl
\$ 1 2 3 4 5 6 7 8 9 0 . , - ' ' : ; ! ? (

DISPLAY: Roman: 14 (Linotype) and regular Display 24, 36

Janson (Linotype)

Roman & Italic & Small Caps: 14

(no machine composition— fonts and sorts and hand set only)

ABCDEFGHIJKLMN~~OP~~QRSTU~~VW~~XYZ &
ABCDEFGHIJKLMN~~OP~~QRSTU~~VW~~XYZ&

ABCDEFGHIJKLMN~~OP~~QRSTU~~VW~~XYZ

12345 abcdefghijklmnopqrstuvwxyz 67890

VBCDE *abcdefghijklmnopqrstu*vwxyz FGRTJ

, . : ; ? ! (|) * ' - - Z Æ Œ Æ Æ & £ \$. . . fi fl ff ffi ffl
, . s ; ? ! A I Q O ' ' - - U Æ Œ Æ Æ N £ P L . . . fi Y ff w M

12345 () : fl ffi ffl \$ æ œ 67890 ; ;

12345 () : fl ffi ffl \$ æ œ 67890 ; ;

§ ¶ - [] H K X Z & Æ Œ @ % * † ‡

SHORT DESCENDERS

g j p q y *g j p q y*

OLD STYLE FIGURES

1 2 3 4 5 6 7 8 9 0 1 2 3 4 5 6 7 8 9 0

Jefferson Gothic — see Gothics section

Jenson Condensed # 258

*abcdefghijklmnopqrstu*vwxyz

ABCDEFGHIJKLMN~~OP~~QRSTU~~VW~~XYZ

\$1234567890

AVOIDING LOST MOTION

Is Just as Important in the Hand Department as in
the Mechanical Department of a Plant

\$1234567890

Roman DISPLAY: 14

Jenson Old Style #58

Jenson aka Italian Old Style, by Phinney & reworked by Goudy.

A B C D E F G H I J K L M N O
P Q R S T U V W X Y Z & Æ Æ
a b c d e f g h i j k l m n o p q r s t
u v w x y z æ œ fi fl ff ffi ffl ✖)
\$ 1 2 3 4 5 6 7 8 9 0 £ . , - ' : ; ! ?

Roman Composition: 8, 10, 12 DISPLAY Roman 14, 18, 24, 30, 36

Joanna #478 (English Monotype)

Released in 1937; designed by Eric Gill. Copy fof typ[es cut for Hague and Gill by W.H. Caslon in 1930

ABCDEFGHIJKLMNOPQRSTUVWXYZ&ÆË

ABCDEFGHIJKLMNOPQRSTUVWXYZ&ÆË

abcdefghijklmnopqrstuvwxyzfi fl ff ffi ffl æ œ

ABCDEFGHIJKLMNOPQRSTUVWXYZ&ÆË

abcdefghijklmnopqrstuvwxyzfi fl ff ffi ffl æ œ

1 2 3 4 5 6 7 8 9 0 1 2 3 4 5 6 7 8 9 0

.,:;!?"-([†‡\$£\$*—\$£])"?!;:,

1234567890 F1609

F1610 1234567890

Roman & Italic: Composition 12, 14

John Hancock #142

c. 1909 based on a Keystone Type Foundry face of 1905.

ABCDEFGHIJKLMNOPQRSTUVWXYZ&ÆË

abcdefghijklmnopqrstuvwxyzæ œ fi fl ff ffi ffl

\$1234567890 .,-“:;!?”

Roman Composition: 6, 8, 12

John Hancock Condensed # 245

NEW MONOTYPE MATERIAL For Every Form Means the Minimum of Expense for the Make-up **\$1234567890**

Roman DISPLAY: 14, 18, 24, 30, 36

Kabel Light— see Sans Serif Light #329 (in Sans Serif section)

Kennerley Old Style #268

Goudy designed the face for Mitchell Kennerley in 1911 and Robert Wiebking cut the matrices.

ABCDEFGHIJKLMN~~OP~~QRSTUVWXYZ&ÆŒ

abcdefghijklmnopqrstuvwxyzæœ ffffffll

\$1234567890 .,‘”:;!?”[]() ctst \$1234567890

ABCDEFGHIJKLMN~~OP~~QRSTUVWXYZ&ÆŒ

ABCDEFGHIJKLMN~~OP~~QRSTUVWXYZ&ÆŒ

abcdefghijklmnopqrstuvwxyzæœ ffffffll

\$1234567890 :;!?” ctst \$1234567890

Roman, Italic & SMALL CAPS Composition: 6, 8, 10, 11, 12 + accents

DISPLAY: Roman: 14, 18^{#1}, 18^{#2}, 24, 30, 36, 48, 60, 72

Italic: 14, 18, 18^{#2}, 24, 30, 36

Large Caps: Roman: 36

Special Italic Swash Fonts

These Special Swash Letters are included in all fonts of Kennerley Italic from 14 to 36 Point, and may also be purchased separately in fonts of each point size

A B C D E M P R T U

Swash: 14, 18^{#1}, 18^{#2}, 24, 30, 36

Small Caps: 14, 18^{#1}, 18^{#2}

(#1 and #2 designate 2 different sizes on the same body; #1 would approximate 16 point on and 18 point body, #2 18 point on 18 point body)

Kennerley Bold #269

ABCDEFGHIJKLMNOPQRSTUVWXYZ&ÆŒ
abcdefghijklmnopqrstuvwxyzæœ ctst flflffflfl

\$1234567890 or \$I234567890£ .,-“”;

ABCDEFGHIJKLMNOPQRSTUVWXYZ&ÆŒ
abcdefghijklmnopqrstuvwxyzæœ ctst flflffflfl

\$1234567890 or \$I234567890 .,-“”;!?

Long descenders
in 6 to 12 Point: **g j p q y J Q** **Ç È É Ê Ë** 10 and 12 Pt. only

Roman & Italic Composition: 6, 8, 10, 12

DISPLAY: Roman: 14, 18^{#1}, 18^{#2}, 24, 30, 36, 48, 60, 72

Italic: 14, 18^{#1}, 18^{#2}, 24, 30, 36

Kennerley Open Caps #368

ABCDEF
GHIJKLMN
OPQRSTU
VWXYZ!?

.,:;-\$12345
67890()

DISPLAY: Roman: 48

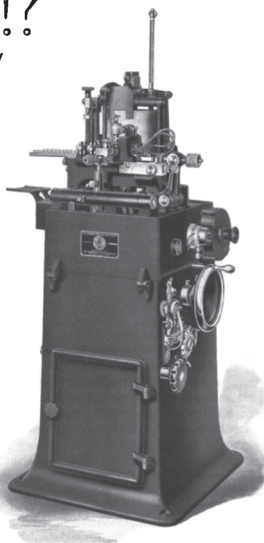

The Thompson foundry-style caster.

Kliluk by Barbara Henry

A new typeface designed by Barbara Henry of Harsimus Press. This is an *asemic* font. For those in the know, this alphabet is for an imaginary language. If a viewer thinks the language is real but just one they don't know, the project is a success. Each character is cast on a quad, so it can be printed as 4 different images when set in lines. The images make wonderful ornamental matter as well. So far seven characters have been engraved. In all there will be 32 characters plus their mirror images.

Kliluk

A sampler of 18 pt Asemic Type

by Barbara Henry



\$35 • Ten pieces each of characters
I-7 and of mirror images of I-3, 5 & 6

Latin Antique #63

abcdefghijklmnopqrstuvwxyz
ABCDEFGHIJKLMNOPQRSTUVWXYZ
\$1234567890

Roman Composition: 8

Display Roman: 18, 24, 30, 36

Law Italic #23

ABCDEFGHIJKLMN OPQRSTUVWXYZ & Æ Æ
abcdefghijklmnopqrstu vwxyzæœ fiffiffiffi
\$1234567890 .,-' :; !?

Italic Composition: 12

Law Italic #115

ABCDEFGHIJKLMN OPQRSTUVWXYZ & Æ Æ
abcdefghijklmnopqrstu vwxyzæœ fiffiffiffi
\$1234567890 .,-' :; !?

Italic Composition: 10, 12

Litho Roman Light (Litho Antique)#162

A revamping of Inland Type foundry of St Louis' type in 1910, basically heading towards Stymie

A B C D E F G H I J K L M N
O P Q R S T U V W X Y Z &
a b c d e f g h i j k l m n o p q r
s t u v w x y z
\$ 1 2 3 4 5 6 7 8 9 0 . , - ' : ; ! ?

Roman Composition: 5, 6, 10, 12

DISPLAY: Roman: 14, 18, 24, 30, 36

Lombardic Caps #310 Lanston & #293 English

Combines nicely with Goudy Text, my matrices are engraved and of uncertain provenance & include a unique pilcrow (not shown) and a different ornament.

Cut by Goudy in 1929, first presented in his book *Elements of Lettering*.

A B C D E F G H I J K L M N
O P Q R S T U V W X Y Z ☩

DISPLAY: Roman: 18 #310 also 12 pt # 293 English Monotype

Lorrain Venus Medium Extended (Bauer)

I think this is *Venus*, taken from Wagner & Schmidt, and done in 1907-27 by Bauer.

Venus Medium Ext ABCDE125&

DISPLAY: Roman: 18

Lucian Bold #104 aka Graphic Bold (Baltotype)

(Baltotype's Electro mats copy of Bauer's font (c. 1925); digital version below.

Lucian Bernhard did the original. Also, aka Bernhard Roman)

ABCDEFGHIJKLMN**OP**QRSTUV
WXYZabcdefghijklmnopqrstu**vwxyz**
\$1234567890 ., ! ?

DISPLAY: Roman: 18, 30, 36, 48

Lutetia #255 (English Monotype)

Created by Jan van Krimpen; released in 1930. Originally cut by Enschedé 1925

ABCDEFGHIJKLMNOPQRSTUVWXYZ&ÆŒ

ABCDEFGHIJKLMNOPQRSTUVWXYZÆŒ

abcdefghijklmnopqrstuvwxyziñffiffiffiæœ

ABCDEFGHIJKLMNOPQRSTUVWXYZ&ÆŒ

abcdefghijklmnopqrstuvwxyziñffiffiffiæœ

1 2 3 4 5 6 7 8 9 0 .,:;!?"'([+|§£\$*-£§+])'?!;,:. 1234567890

ALTERNATIVE CHARACTERS AND FIGURES

1234567890 F271 U 226 e 378 F720 1234567890

A SELECTION OF SWASH LETTERS

A B C D E G H J K M N P Q R T
U Y e k m n r L v w z ã st ã

Roman, Italic & Swash Composition: 12D on 14, 14 D on 16, Roman 20D on 22

Lydian and Lydian Bold: See Sans Serif section

MacFarland #68

TYPE RUN ROUND CUTS AND INITIALS

Like straight Matter, just as Accurately as with Matter Composed by and Run Round by Hand in the Old Way

\$1234567890

DISPLAY: 14, 18, 24

Manila #92 (c. 1909, by Lanston Monotype)

ABCDEFGHIJKLMNOPQRSTUVWXYZ&ÆŒ

abcdefghijklmnopqrstuvwxyzae fiñffiffiffi

\$1234567890 .,-“”:;!?

Roman Composition: 6, 8

Masterman #158

Bold variation of Doric, Lanston Monotype 1910

A B C D E F G H I J K L M N O
P Q R S T U V W X Y Z & Æ Œ
a b c d e f g h i j k l m n o p q
r s t u v w x y z æ œ fi fl ff ffi ffl
\$ 1 2 3 4 5 6 7 8 9 0 £ . , - ' : ; ! ?

Roman Composition: 6, 8, 10, 12
DISPLAY: Roman: 14, 18, 24, 30, 36

Melior #125

By Hermann Zaph for Stempel c. 1952

abcdefghijklmnopqrstuvwxy
ABCDEFGHIJKLMN OPQRSTUVWXYZ-\$123
abcdefghijklmnopqrstuvwxy
ABCDEFGHIJKLMN OPQRSTUVWXYZ-\$123

Roman Composition: 6, 7, 8, 9, 10, 11
Italic: 8, 9, 10, 11

Melior Bold #180

abcdefghijklmnopqrstuvwxyABCDEFGHI
HIJKLMN OPQRSTUVWXYZ-\$12

Roman Composition: 9, 10, 11

Modern, Antique #26— see Antique Modern
Modern, Antique Condensed #76— see Antique Condensed Modern

Modern Condensed #1

Typical English face design; modern usually denotes unbracketed serifs as the hallmark, as in Bodoni and Didot, with Bell or Baskerville being seen as transitional examples.

ABCDEFGHIJKLMN**OP**QRSTU**VW**XYZ&ÆŒ
abcdefghijklmnopqrstu**vw**xyzæœ fiffiffiffi
\$1234567890 .,-“:;!?

ABCDEFGHIJKLMN**OP**QRSTU**VW**XYZ&ÆŒ
*ABCDEFGHIJKLMN**OP**QRSTU**VW**XYZ&ÆŒ*
*abcdefghijklmnopqrstu**vw**xyzæœ fiffiffiffi*
\$1234567890 :;!?

Roman, Italic & Small Caps Composition: 6, Roman & small caps 8, 10

Modern Number 3 Extra Cond. #216

abcdefghijklmnopqrstu**vw**xyz
ABCDEFGHIJKLMN**OP**QRSTU**VW**XYZ
\$1234567890

Roman Composition: 8

Modern #8

ABCDEFGHIJKLMN**OP**QRSTU**VW**XYZ&ÆŒ
abcdefghijklmnopqrstu**vw**xyzæœ fiffiffiffi
\$1234567890 .,-“:;!?

ABCDEFGHIJKLMN**OP**QRSTU**VW**XYZ&ÆŒ
*ABCDEFGHIJKLMN**OP**QRSTU**VW**XYZ&ÆŒ*
*abcdefghijklmnopqrstu**vw**xyzæœ fiffiffiffi*
\$1234567890 :;!?

Roman, Italic & SMALL CAPS Composition: 4, 4 1/2, 5, 6, 7, 8, 10, 11, 12 + accents

Modern #10

Roman Composition: 5.5 pt roman

Have no specimen; not listed in McGrew ! But looks like basic "Modern"

Modern Medium Condensed #14

ABCDEFGHIJKLMNOPQRSTUVWXYZ&ÆŒ

abcdefghijklmnopqrstuvwxyæœ fiffiffiff

\$1234567890 .,-' ;!?

Roman Composition: 8

Modern Number Four, #34

ABCDEFGHIJKLMNOPQRSTUVWXYZ&ÆŒ

abcdefghijklmnopqrstuvwxyæœ fiffiffiff

\$1234567890 .,-' ;!?

ABCDEFGHIJKLMNOPQRSTUVWXYZ&ÆŒ

ABCDEFGHIJKLMNOPQRSTUVWXYZ&ÆŒ

abcdefghijklmnopqrstuvwxyæœ fiffiffiff

\$1234567890 ;!?

Composition Roman & Italic: 9,10; Roman 11

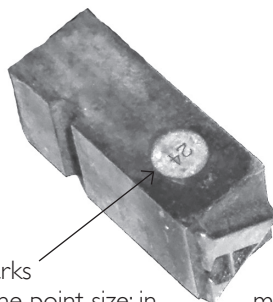
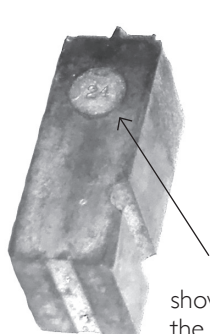

Pin marks show "24": the point size; in the name of the foundry or a symbol for the foundry. A

In this case they many cases they have

pin mark almost always indicates foundry cast vs Monotype, although the Thompson can use a pin mark and make a groove at the foot similar to true foundry type.

Modernistic #297

Designed by W.A. Parker for ATF c. 1927

CHARACTERS IN FONT

A B C D E F
G H I J K L
M N O P Q
R S T U V
W X Y Z &
\$ 1 2 3 4 5
6 7 8 9 0
. , - ' ; : ?
! " # \$ % &

18 to 36 Point—49 Characters

DISPLAY: 30, 36

Narcissus (Linotype)

Designed by Walter Tiemann in 1921 for the Klingspor Foundry in Germany.

O Hambur gefonstiv

O Hambur gefonstiv nature Hoffnung Habsburg
Oberfoerster Hornisse Otto amuse sonnentau tassetee
inserrat moostauben monsunregen frage abteigruft nortvone
mitgabe turnverein namensgebung miinnora bagger

Special Display casting Roman: 12, 18, 20, 30, 36, 48

News Gothics see Gothics Section

Nicolas Cochin #461 — see Cochin, Nicolas

Nicholas Cochin Bold, see Cochin Nicholas

Othello (English Monotype) # 246

Composition 12 pt

SYNOPSIS IN 14 POINT

**ABCDEFGHIJKLMNOPQRSTUVWXYZ&
£1234567890 .,:;!?"'-(\$ —**

Linotype slugs and mats. The mat showing the casting cavity for an "N" is a duplex, which allows two different faces to be punched onto one mat. Often roman and italic accompany each other. The disadvantage to this set up is both must be the same set width.

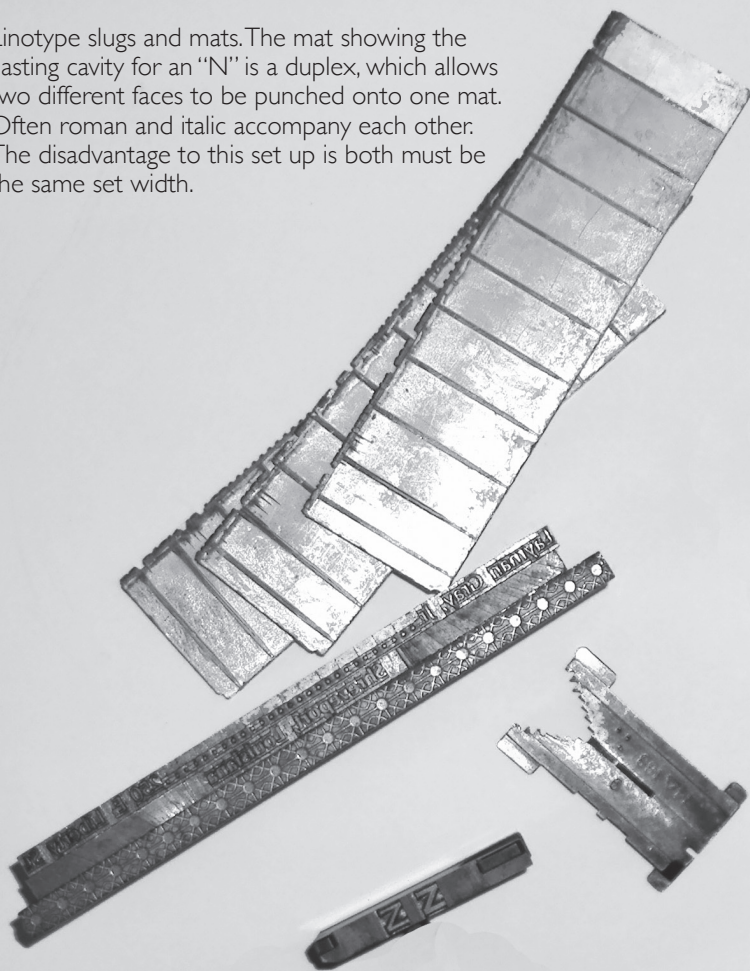

Onyx #404

Designed by Gerry Powell c1937 for ATF, based on "fat faces"

A B C D E F G H I J K L M N O P Q R S T

U V W X Y Z &

a b c d e f g h i j k l m n o p q r s

t u v w x y z

\$ 1 2 3 4 5 6 7 8 9 0 \$ ¢ % . , - ' ' : ; ! ? ()

A B C D E F G H I J K L M N O P Q

R S T U V W X Y Z &

a b c d e f g g h i j k l m n o p q r

s t u v w x y z

\$ 1 2 3 4 5 6 7 8 9 0 . , - ' ' : ; ! ? ()

Display Roman: 18, 24, 30, 36, 42, 48, 60, 72, 72H4

Italic: 24, 30, 36, 42, 60, 72

Pabst Old Style #45

Designed by Goudy c. 1902; Inland made a copy called "Avil," another copy was "Latina"; for the brewing company

abcdefghijklmnopqrstuvwxyz
ABCDEFGHIJKLMNOPQRSTUVWXYZ
\$1234567890

Roman Composition: 6, 8, 10, 12
DISPLAY: Roman: 14, 18, 24, 30, 36

Parisian &
Park Avenue
— see Scripts

Pastonchi (English Monotype) #206

Designed by F. Pastonchi and E. Cotti for English Monotype, c. 1927

ABCDEFGHIJKLMNOPQRSTUVWXYZ&ÆŒ
ABCDEFGHIJKLMNOPQRSTUVWXYZÆŒ
abcdefghijklmnopqrstuvwxyzfi flffiffi flæœ
ABCDEFGHIJKLMNOPQRSTUVWXYZ&ÆŒ
abcdefghijklmnopqrstuvwxyzfi flffiffi flæœ
1234567890 .,:;!?'“(†\$£\$*—\$\$†)‘’?;!,:; 1234567890
A B C D E H L M N P Q R T U Z a e n v w

Roman, Italic, Small Caps & Swash Composition: 12D=13 point on 14 body

Pepita #613— see Scripts

Perpetua (English Monotype) #239

By Eric Gill, released in 1928., and his most popular face. It was first used in
The Passion of Perpetua and Felicity.

ABCDEFGHIJKLMNOPQRSTUVWXYZ&ÆŒ

ABCDEFGHIJKLMNOPQRSTUVWXYZÆŒ

abcdefghijklmnopqrstuvwxyzfiflffffflæœ

ABCDEFGHIJKLMNOPQRSTUVWXYZ&ÆŒ

abcdefghijklmnopqrstuvwxyzfiflffffflæœ

1 2 3 4 5 6 7 8 9 0 . , ; ! ? ' - ([† ‡ § £ \$ * — † ‡ § £ \$ *) ' ? ! ; : , 1 2 3 4 5 6 7 8 9 0

SOME SELECTED ALTERNATIVE CHARACTERS & FIGURES

U 8 y 131 y 139 J 83 U 226

1234567890 F682

1234567890 F683

Roman, Italic & SMALL CAPS Composition: 6, 8, 9, 10, 11, 12, 13, 14

DISPLAY: Italic 24 (18, 24, 30, 36 Roman & Italic can be had with notice)^{F/SN}

Perpetua Titling #258 (English Monotype)

ABCDEFGHIJKLMNOPQRSTUVWXYZ&ÆŒ

ALTERNATIVE CHARACTERS

£1234567890 R₁₉₈ U₂₂₆ J₉₃ . , ; ! ? ' - ([† ‡ § £ \$ * —

Roman Display: 14, 18, 24, 30, 42, 48, 60, 72

Plantin #110 (English Monotype)

Released in 1913, based on Granjon's work in the Musée Plantin in Antwerp.

ABCDEFGHIJKLMNOPQRSTUVWXYZ&ÆŒ

ABCDEFGHIJKLMNOPQRSTUVWXYZÆŒ

abcdefghijklmnopqrstuvwxyzfiflffffflæœ

ABCDEFGHIJKLMNOPQRSTUVWXYZ&ÆŒ

abcdefghijklmnopqrstuvwxyzfiflffffflæœ

1234567890 . , ; ! ? ' - ([† ‡ § £ \$ * — ' ? ! ; : , F112 1234567890

Roman, Italic & SMALL CAPS Composition: 7, 8, 9, 10, 12

Plantin Bold #194 (English Monotype)

ABCDEFGHIJKLMN OPQRSTUVWXYZ & Æ Æ

abcdefghijklmnopqrstu vwxyz fi fl ffi flæ æ

ABCDEFGHIJKLMN OPQRSTUVWXYZ & Æ Æ

abcdefghijklmnopqrstu vwxyz fi fl ffi flæ æ

1234567890 .,:;!?"-([†‡§£\$*—\$£\$†])-“ ’?!,; 1234567890

Roman Composition: 7, 8, 9, 10, 12

Plymouth #60

Takeoff of the arts & crafts *Roycroft*, Lanston c. 1905 & BB&S in 1900; aka
Rugged Black

A B C D E F G H I J K L M N O

P Q R S T U V W X Y Z @ Æ Æ

a b c d e f g h i j k l m n o p q r s t

u v w x y z æ œ fi fl ff

\$ 1 2 3 4 5 6 7 8 9 0 £ ., - ' : ; ! ?

A B C D E F G H I J K L M N N O

P Q R R S T U U W X Y Z & Æ Æ

a b c d e f g h i j k l m n o p q r s t

u v w x y z æ œ fi fl ff ç

\$ 1 2 3 4 5 6 7 8 9 0 £ ., = ' : ; ! ?

Roman Composition: 10, 12

DISPLAY: Roman & Italic: 14, 18, 24, 30, 36

Post #5

Designed for or in imitation of the Saturday Evening Post's typeface by E.J.
Kistson c. 1900.

ABCDEFGHIJKLMN OPQRSTUVWXYZ & Æ Æ

abedefghijklmnopqrstu vwxyzæœ fi fl ffi flfl

\$1234567890 .,-“ ’:;!?

Roman Composition: 5.5, 6

Powell #97

Designed by Goudy for the same guy who commissioned Pabst, this time for a different customer, a department store.

**A B C D E F G H I J K L M N
O P Q R S T U V W X Y Z &
a b c d e f g h i j k l m n o p q r s t u v
w x y z fi fl ff**

\$ 1 2 3 4 5 6 7 8 9 0 . , - ' : ; ! ?

**A B C D E F G H I J K L M N
O P Q R S T U V W X Y Z &
a b c d e f g h i j k l m n o p q r s t u v
w x y z fi fl ff ffi ffi**

\$ 1 2 3 4 5 6 7 8 9 0 . , - ' : ; ! ?

Composition: Roman: 6, 10, 12; Italic: 12
Display: Roman: 14, 18, 24, 30, 36

Process #138

Face for the Crowell Publishing Co by Lanston c. 1939.

**ABCDEFGHIJKLMNOPQRSTUVWXYZ&
abcdefghijklmnopqrstuvwxyz**

ffiffiffi \$1234567890 .,:;!?() —*%“ ”

ABCDEFGHIJKLMNOPQRSTUVWXYZ&

**ABCDEFGHIJKLMNOPQRSTUVWXYZ&
abcdefghijklmnopqrstuvwxyz fffiffiffi .,:;!?() —*%“ ”**

Roman, Italic & Small Caps: Composition

Rivoli (Intertype)

Designed by William Sniffin for Atf c. 1928.

INTERTYPE faces are made on modern
wide tooth matrices which 12345

Special DISPLAY casting: 10, 12, 14, 18

Rockwell Antique # 189— see Stymie Bold
Rockwell Antique Shaded # 193— see Stymie Bold Shaded

Ronaldson #16

A face by MS & Jordan in 1884 & copied widely

12345 abcdefghijklmnopqrstuvwxyz 67890\$
ABCDEFGHIJKLMN OPQRSTUVWXYZ
ABCDEFGHIJKLMN OPQRSTUVWXYZ

Roman Composition: 6, 10, 12

SMALL CAPS: 6, 10, 12

Romulus #458 (English Monotype)

Designed by Jan van Krimpen, c 1931; released by Monotype in 1936. Originally
cut by Enschedé in 1931

ABCDEFGHIJKLMN OPQRSTUVWXYZ & Æ Æ

ABCDEFGHIJKLMN OPQRSTUVWXYZ Æ Æ

abcdefghijklmnopqrstuvwxy z f i f f f f f f l æ œ

ABCDEFGHIJKLMN OPQRSTUVWXYZ & Æ Æ

abcdefghijklmnopqrstuvwxy z f i f f f f f f l æ œ

1234567890 1234567890

.,:;!?"-([†‡§£\$*-£‡†])"?!;:,

ALTERNATIVE CHARACTER AND FIGURES

1234567890 F724 f 254 F721 1234567890

Roman & Italic Composition: 12D on 14, 14D on 16

Ruthenian / Russian 308/318 see Foreign Section

Runic Condensed #98 (Thompson)

(Digital specimen below) c. 1935

ABCDEFGHIJKLMNOPQRSTUVWXYZ

abcdefghijklmnopqrstuvwxyz

!?,,: '\$1234567890

DISPLAY: Roman: 24, 30, 36

Sans Serif (Monotype Sans Serif aka Kabel) #329 etc., see Sans Serifs!

Schoeffer #69

Designed by Herman Ihlenburg for ATF c. 1897, Linotype version "Elzevir"

abcdefghijklmnopqrstuvwxyz

ABCDEFGHIJKLMNOPQRSTUVWXYZ

\$1234567890

Roman Composition: 12

Scotch Roman #36

Reworking of a face from Alexander Wilson & Son of Scotland c 1883; Farmer & Sons did a version in 1903, folded into ATF later; Lanston version 1908

ABCDEFGHIJKLMNOPQRSTUVWXYZ&ÆŒ

abcdefghijklmnopqrstuvwxyzæœ fiffiffiffi

\$1234567890 ,-' :; !?

ABCDEFGHIJKLMNOPQRSTUVWXYZ&ÆŒ

ABCDEFGHIJKLMNOPQRSTUVWXYZ&ÆŒ

abcdefghijklmnopqrstuvwxyzæœ fiffiffiffi

\$1234567890 :;!?

Roman, Italic & SMALL CAPS Composition: 6, 8, 9, 10, 11, 12

DISPLAY: Roman: 14, 18, 24, 30, 36, 48 Italic: 14, 18, 24, 30, 36 + swash

Scotch Open Swash #316So

A B C D M N
K L P R R R U

DISPLAY: 36 Italic



Shadow — see Scripts
Spartan (English) #140 — see Gothics (it's a Copperplate)

Spectrum #556 (Eng)

Created by Jan van Krimpen c.1955. Originally cut by Enschedé in 1952

SYNOPSIS IN 10D ON 11 POINT

ABCDEFGHIJKLMN**OP**QRSTUVWXYZ&ÆŒ

ABCDEFGHIJKLMN**OP**QRSTUVWXYZ&ÆŒ

abcdefghijklm**nop**qrstuvwxyzfi~~ff~~ff~~ff~~flæœ

ABCDEFGHIJKLMN**OP**QRSTUVWXYZ&ÆŒ

abcdefghijklm**nop**qrstuvwxyzfi~~ff~~ff~~ff~~flæœ

1234567890 .,:;!?'-([†‡§£\$*-£\$†])'?!;:,. 1234567890

ALTERNATIVE FIGURES

1234567890 F990 F991 1234567890

1234567890 F1068 F1069 1234567890

Roman, Italic, SMALL CAPS: Composition: 8D (9 pt)



Hand-correcting a galley of composition type. Note the spacing is included and the type is justified left and right.

Spire #377

Designed by Sol Hess for Lanston in 1937

A B C D E F G H I J K L M N O P Q R
R S T U V W X Y Z &
\$ 1 2 3 4 5 6 7 8 9 0 ¢ . , - ' ' ! ?) |

DISPLAY: Roman: 24, 30, 36, 48

Stencil (ATF #662)* (c. 1937, looks like Ludlow version by Middleton)

A B C D E F
G H I J K L
M N O P Q R
S T U V W X
Y Z & . , - ' ' : ; !
? - ♦ 1 2 3 4 5
6 7 8 9 0 \$

DISPLAY: Roman: 18, 24, 30

*My matrices are engraved and of unknown origin. Engraving mats is an alternative to the difficult process of electroplating or the even more arduous process of carving or engraving punches and then striking mats in a punch press. The main difference between engraved mats and mats otherwise produced is that since the engraving tool must be cone-shaped, the casting cavity has a sloped side-wall which means the type cannot fit as tightly side to side as punched mats, for instance, because a punched mat can have a vertical side-wall. In the case of Stencil, however, the fit is loose and the issue of tight fit is moot.

Stymie Light #190

AAABCDEF GHIJKLMNOPQRRSTUVWXYZ&
aabcdeffghijklmnopqrstuvwxyz
\$1234567890 .,-'::!/?«»)*\$%
ABCDEF GHIJKLMNOPQRRSTUVWXYZ&
aabcdeffghijklmnopqrstuvwxyz
\$1234567890 .,-'""::!/?«»()

Roman Composition: 6, 8, 10, 12 + accents (composition & fonts)
Italic: 6* 8* 10* 12* (Sorts & Fonts)
DISPLAY Roman: 14, 18, 24, 30, 36, 42, 48, 70, 72
Italic: 14, 18, 24, 30, 36

Stymie Medium #290

AAABCDEF GHIJKLMNOPQRRSTUVWXYZ&
aabcdeffghijklmnopqrstuvwxyz
\$1234567890 .,-'::!/?«»*\$()
ABCDEF GHIJKLMNOPQRRSTUVWXYZ&
aabcdeffghijklmnopqrrstuvwxyz
\$1234567890 .,-'""::!/?()

Roman Composition: 6, 8, 10, 12 + accents
DISPLAY: Roman: 14, 18, 24, 30, 36, 42, 48, 60 Italic: 18, 30, 36

Stymie Medium Condensed #590

A A B C D E F G H I J K K L M N O P Q R R S T
U V W X Y Z &
a a b c d e f g h i j k l m n o p q r s t t u v w x y y z
\$1234567890 \$ ¢ .,-'':;!/?«»[(

DISPLAY: Roman: 14, 18, 24, 30, 36

Stymie Bold (Rockwell Antique) #189

A A A B C D E F G H I J J K K L M N
O P Q R S T U V W X Y Z & Æ Æ
a a b c d e f f g h i j k k l m n o
p q r r s t t u v w x y y z æ œ
\$ 1 2 3 4 5 6 7 8 9 0 . , - ' : ; ! ?

A B C D E F G H I J K L M N O
P Q R S T U V W X Y Z &
a b c d e f f g h i j k l m n o p q r
r s t u v w x y z
\$ 1 2 3 4 5 6 7 8 9 0 £ . , - ' ' : ; ! ?

Roman Composition: 6, 8, 10, 12 + accents
DISPLAY: Roman: 14, 18, 24, 30, 36, 48, 60, 72
Italic: 14, 18, 24, 30, 36

Stymie Bold Shaded #193 (Rockwell Shaded)

A B C D E F G H I J K L M N O P
Q R S T U V W X Y Z &
a b c d e f g h i j k l m n o p q r s t u v
w x y z . , - : ; ' ! ? \$ 1 2 3 4 5 6 7 8 9 0

DISPLAY: Roman: 12, 18, 24, 30, 36

Stymie was developed by Morris Benton at ATF, taking design ideas from Parsons, Rockwell Antique (derived from Litho Antique by Inland Type Foundry).

Stymie Bold #790

**AAABCDEF GHIJKLMNOPQRRSTUV
WXYZ&**

aabcdeffghijklmnopqrrstuvwxyz

\$1234567890 .,-'":!?

ABCDEF GHIJKLMNOPQRRSTUVWXYZ&

abcdeffghijklmnopqrrstuvwxyz

\$1234567890 .,-'":!;?()

Roman & Italic: Composition 6, 10, 12

DISPLAY: Roman: 14, 18, 24, 30, 36

Stymie Extra Bold #390

ABCDEF GHIJKLMNOPQRSTUVWXYZ&

abcdeffghijklmnopqrstuvwxyz

\$1234567890\$¢ \$1234567890

.-'":!;?« »[]() AKRatyy

ABCDEF GHIJKLMNOPQRSTUVWXYZ &

abcdeffghijklmnopqrstuvwxyz Ka

\$1234567890 .,-'":!;?[]()

Roman Composition: 8, 10, 12 + accents
DISPLAY: Roman: 14, 18, 24, 30, 36, 48, 60, 72
Italic: 14, 18, 24, 30, 36

English style display matrices engraved on the Benton
Pantograph for Starshaped Press



Stymie Extra Bold Condensed #490

A A B C D E F G H I J K K L M N O P
Q R R S T U V W X Y Z &
a a b c d e f g h i j k l m n o p q r s t
t u v w x y y z
\$ 1 2 3 4 5 6 7 8 9 0 \$ ¢ . , - ` ' : ; ! ? ([« »

DISPLAY: Roman: 14, 18, 24, 30, 36, 48, 60, 72

Suburban French #172

One of the first Lanston faces taken from European designs c. 1911, with ideas from Horace Macfarland and Willian D. Orcutt, and probably based on Didot from 1804...

ABCDEFGHIJKLMN OPQRSTUVWXYZ&ÆŒ
abcdefghijklmnopqrstu vwxyzæœ fiffiffiffi
\$1234567890 .,-“:;!?

ABCDEFGHIJKLMN OPQRSTUVWXYZ&ÆŒ
ABCDEFGHIJKLMN OPQRSTUVWXYZ&ÆŒ
abcdefghijklmnopqrstu vwxyzæœ fiffiffiffi
\$1234567890 :;!?

Roman, Italic & SMALL CAPS Composition: 12

Tallone Max Factor #32

Proprietary face for the cosmetics company c. 1956

ABCDEFGHIJKLMN OPQRSTUVWXYZ&
abcdefghijklmnopqrstu vwxyz fiffiffiffi \$1234567890
ABCDEFGHIJKLMN OPQRSTUVWXYZ&
ABCDEFGHIJKLMN OPQRSTUVWXYZ&
abcdefghijklmnopqrstu vwxyz fiffiffiffi \$1234567890
\$1234567890 .,-:;!?()—% “ ”

Roman, Italic, SMALL CAPS Composition: 8, 9, 12 (All long descenders)

Times New Roman #327 (English Monotype)

Designed by Stanley Morrison, released in 1932, for the London *Times*. It was the most successful face of the 20th Century and used extensively in this century.

ABCDEFGHIJKLMN**OP**QRSTUVWXYZ&ÆŒ

ABCDEFGHIJKLMN**OP**QRSTUVWXYZ&ÆŒ

abcdefghijklmnopqrstuvwxyziiflffiffllæœ

*ABCDEFGHIJKLMN**OP**QRSTUVWXYZ&ÆŒ*

abcdefghijklmnopqrstuvwxyziiflffiffllæœ

1234567890 .,:;!?"'-([†‡§£\$*—\$£'?!:;, 1234567890

1234567890 F476 ALTERNATIVE FIGURES F1091 *1234567890*

Composition: Roman, Italic, SMALL CAPS: 6, 7, 8, 9, 10, 11, 12

Roman, Italic, SMALL CAPS: 12 long descenders on 14

DISPLAY: Roman: 14, 18, 24, 30, 36, 48, Italic: 14, 18, 24, 30

Roman 14 small caps (Linotype) special casting

(We also have some Lanston Times New Roman #362)

Times New Roman Bold #334 (English Monotype)

ABCDEFGHIJKLMNOP**QRSTUVWXYZ&**

abcdefghijklmnopqrstuvwxyziiflffiffllæœ \$1234567890 .,:;!?"'— ()“”

Roman Composition: 6, 7, 8, 9, 10, 11, 12

DISPLAY: Roman: 24, 30, 36

Title #28

ABCDEFGHIJKLMNOP**QRSTUVWXYZ&ÆŒ**

abcdefghijklmnopqrstuvwxyziiflffiffllæœ

\$1234567890 .,-“:;!?"

Roman Composition: 5.5, 6, 8

Title, Half #905 see Half Title

Tourist Gothic — see Modern Gothic Condensed — § Gothics

Twentieth Century (Futura) — see Sans Serif section

Twist, a boxed set by SONYA CLARK

Twist, a hair based font, challenges the cultural supremacy of the Roman alphabet and resists the European dominance inherent in its widespread use.

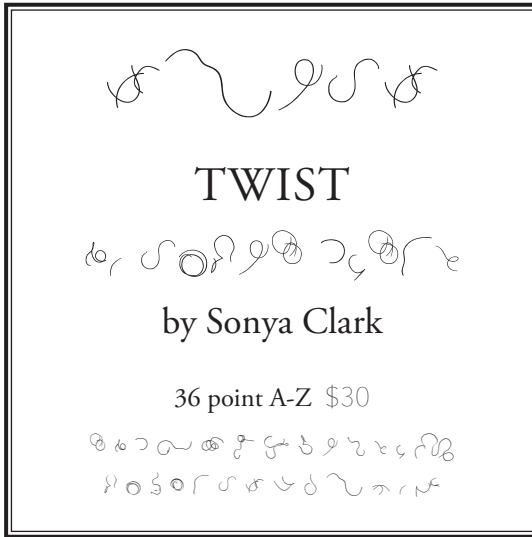

Twist follows the curl pattern of African hair. It re-centers Africa as the cradle of all humanity and returns us to our roots. Inspired by the curly DNA-filled strands of hair, *Twist* serves as a genetic reminder of our ancestry. In his ground breaking book, *Decolonizing the Mind: The Politics of Language in African Literature*, Ngũgĩ wa Thiong’o wrote “language as culture is the collective memory bank of a people’s experience in history.” The seminal text encourages African writers to publish works in any of the thousands of native languages rather than those of the colonizers. Yet, even when an African author follows Ngũgĩ’s directive, indigenous languages, the culture held in the words, are relegated to the colonizers’ Roman-based script.

Twist was digitally formatted by graphic designer, Bo Peng, *Twist* was named by poet laureate, Rita Dove.”

—Sonya Clark

Twist characters

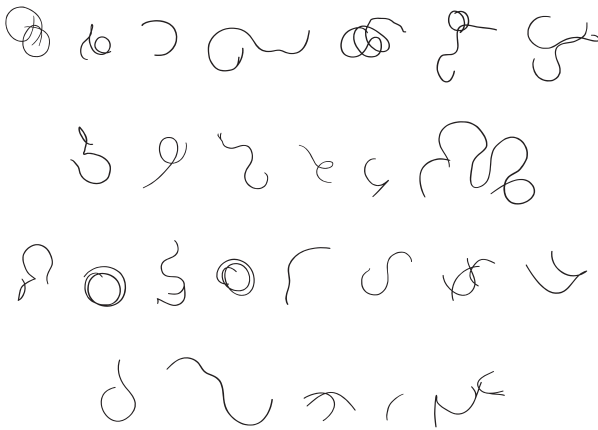

1/8 Font \$95.00

A digital font will also be available soon.

Typewriter Remington Ribbon 17 L

ABCDEFGHIJKLMNOPQRSTUVWXYZ&Æ
abcdefghijklmnopqrstuvwxyz
\$1234567890 . , - : ; ! ? () ' "

Roman Composition: 11

Typewriter Remington #70 L (c. 1900)

ABCDEFGHIJKLMNOPQRSTUVWXYZ&
abcdefghijklmnopqrstuvwxyz
. , - : ; ! ? ' " \$1234567890

Roman Composition: 10, 12
DISPLAY: Roman: 24

Typewriter Reproducing #72 L

ABCDEFGHIJKLMNOPQRSTUVWXYZ&Æ
abcdefghijklmnopqrstuvwxyzæ
. , - ' : ; ! ? () ' " \$1234567890

Roman Composition: 6, 8, 10, 11, 12 (some accents)

Typewriter Mailing List #74 L

ABCDEFGHIJKLMNOPQRSTUVWXYZ&
abcdefghijklmnopqrstuvwxyz
. , - : ; ! ? ' " \$1234567890 %

Roman: 8, 10

Typewriter Underwood #270 L

ABCDEFGHIJKLMNOPQRSTUVWXYZ&
abcdefghijklmnopqrstuvwxyz
. , - : ; ' " ! ? () ' " \$ 1 2 3 4 5 6 7 8 9 0

Roman Composition: 10

Typewriter Remington Underscore #370L

ABCDEFGHIJKLMNOPQRSTUVWXYZ&
abcdefghijklmnopqrstuvwxyz
' " \$ 1 2 3 4 5 6 7 8 9 0 % @ % ! b £ / c # \$ + x = ° * |
. , - : ; ! ? () []

Roman Composition: 10, 12

Typewriter Reproducing Underscore #372 L

ABCDEFGHIJKLMNOPQRSTUVWXYZ&
abcdefghijklmnopqrstuvwxyz
' " \$ 1 2 3 4 5 6 7 8 9 0 . , - ' : ; ! ? ()

Roman Composition: 6, 8, 10, 12

Typo Roman Shaded (Intertype)

Designed by Morris Benton at ATF c. 1921; Typo faces aka Tiffany.

INTERTYPE matrices excel in type design
and manufacturing methods w 12345

Special DISPLAY casting: 14, 16

Vance Gerry

ENGRAVED FLOWERS

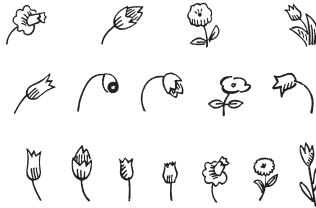

5 each of 16 flowers, 18 pt. \$25

A special casting with the help of Whittington Press of ornaments designed by Vance Gerry.

Gerry was raised in Pasadena, California, where he apprenticed at the Castle Press of Grant Dahlstrom as a teenager & caught the letterpress bug. He trained as a commercial artist and attended the Chouinard Art Institute, under the G.I. Bill, where he studied under the renowned animation artist Donald W. Graham.

In 1955 he worked at the Walt Disney Animation Studio as a layout and story sketch artist. He has contributed to films such as *Sleeping Beauty*, *101 Dalmatians*, *Winnie-the-Pooh*, and so on, finishing up with *The Lion King*.

After Disney he returned to his roots as a letterpress printer and from 1967 ran the *Weather Bird Press* in the Los Angeles area. The press moved from Laguna Beach, where it was called the *Peach Pit Press*, to Fallbrook, & finally to Pasadena. He illustrated most of his books with his line drawings, linoleum cuts, and pochoir. He also wrote and printed several books under the pseudonym of Bunston Quayles.

He gave serious thought to designing his own typeface, and acquired typefounding equipment & a Thompson caster. He worked at cutting punches. Somewhere along the line he did have these ornaments engraved.

Gerry died March 5, 2005 and UCLA holds the *Weather Bird Press Archive, 1966-1992* at the William Andrews Clark Memorial Library in Los Angeles.

These ornaments are available from Swamp Press in the USA and Whittington Press in the UK.

Ultra Bodoni #675 see Bodoni, Ultra
Univers & Valiant— see Sans Serif section

Veronese #59 (English Monotype)

(Digital specimen below, metal version has hanging figures, not lining as shown,
and serifs are more square than as tapered as shown. The face was discontinued
when the Univers series was made, due to lack of storage space.)

ABCDEFGHIJKLMNOPQRSTUVWXYZ

abcdefghijklmnopqrstuvwxyz.,!?:;

01234567890\$

DISPLAY: Roman: 14

Victoria Italic #224

made by many foundries, version of a popular 19th century face

ABCDEFGHIJKLMNOPQRSTUVWXYZ

\$ 1 2 3 4 5 6 7 8 9 0

Italic Composition: 10

Wedding Text #388

Designed by Morris benton of ATF c. 1901; aka *Lino Text* by Linotype &
Society Text by Hanson and Ludlow.

A B C D E F G H I J K L M N O P

Q R S T U V W X Y Z &

a b c d e f g h i j k l m n o p q r s t u v w

x y z st ud rd th or

\$ 1 2 3 4 5 6 7 8 9 0 . , - ' : ; ! ?

DISPLAY: 10, 12

Linotype matrices for 12, 14, 18, 24, 30, 36 “Lino Text”

Winchell #39

Designed by Edward Everett Winchell (of Buffalo, NY) for Inland in 1903

abcdefghijklmnopqrstuvwxy
ABCDEFGHIJKLMNOPQRSTUVWXYZ
\$1234567890

Roman Composition: 12
DISPLAY: Roman: 14, 18, 24

Winchell Condensed #119

abcdefghijklmnopqrstuvwxy
ABCDEFGHIJKLMNOPQRSTUVWXYZ
\$1234567890

Roman Composition: 10, 12
DISPLAY: Roman: 14, 18, 24, 30, 36

Fig. 5.

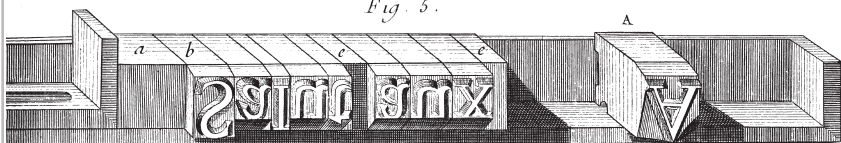

II. Sans Serifs & *Scripts*



SWAMP PRESS

Adonis (Intertype)

Designed by William T. Sniffin for ATF in 1930.

INTERTYPE matrices excel in type
design and manufacture 12345

Special DISPLAY casting: 10, 12, 14, 18

Admiral Script (Ludlow)

Characters in Complete Font

A B C D E F G
H I J K L M N
O P Q R S T U
V W X Y Z &
\$ 1 2 3 4 5 6 7 8 9 0
a b c d e f g h i j k l m n
o p q r s t u v w x y z
. : , ; - ' ' ! ? () [] -

Characters listed below sold separately

τ δ %
1/4 1/3 1/2 2/3 3/4

Special DISPLAY casting: 14, 18, 24, 30, 36, and 48 (caps only, missing U)

Bernhard Fashion (Intertype)

Designed by Lucian Bernhard for ATF c. 1929.

ABCDEFGHIJKLMNOPQRSTUVWXYZ & : ; , ' " - ? ! \$ 1 2 3 4 5 6 7 8 9 0
abcdefghijklmnopqrstu vwxyzabcdefghijklmnop

Special DISPLAY casting: 12, 14, 18

Braggadocio #278 (English)

Designed by W.A. Woolley in 1930 for the Monotype Corporation, somewhat based on Futura (aka 20th Century).

SYNOPSIS IN 18 POINT

**A B C D E F G H I J K L M N
O P Q R S T U V W X Y Z &
a b c d e f g h i j k l m n o p q r
s t u v w x y z æ œ
1 2 3 4 5 6 7 8 9 0
.,:;!?"-([*f:\$- A E E**

DISPLAY: 18

Brush #302

Designed by Robert E. Smith for ATF c. 1942

A B C D E F G H I J K L M N O P Q
R S T U V W X Y Z &
a b c d e f g h i j k l m n o p q r s t u v
w x y z ' e ' s t h t t
.. - ' ' " : : ! ? () . \$ 1 2 3 4 5 6 7 8 9 0 %

DISPLAY: 14, 18, 24, 30, 36, 42, 48, 60, 72

Chamfer Condensed #121

Popular 19th century design which ATF was making by 1871.

24 Point No. 121

ALL COSTLY ERRORS IN ADVERTISING THROUGH
WORN-OUT TYPE ARE
ENDED FOREVER IN THE MONOTYPE SHOP
\$123467890

DISPLAY: Roman: 24, 36 (note: face is caps only + figs & punctuation)

Coronet (Ludlow #42-MIC) ^{SE}

Designed by Middleton for Ludlow in 1937.

Photographers' Convention Begins 62
With large exhibit of examples of good
commercial photography and portraits

18 Point Ludlow 42-MIC Coronet
Length of lower-case alphabet: 120 points

Characters in Complete Font

A B C D E F G

H I J K L M N

O P Q R S T U

V W X Y Z & \$

1 2 3 4 5 6 7 8 9 0

a b c d e f g h i j k l m n

o p q r s t u v w x y z

. : , ; - ' ' ' ! ? - () []

Characters listed below sold separately

F T J %

For fractions see fraction specimen pages

Special Ludlow DISPLAY casting: 14, 18, 24, 36, 48

Coronet Bold (Ludlow # 42-BIC) ^{SE}

*Composing Room of Evening 86
Globe has increased its efficiency
with the Ludlow all-slug system*

18 Point Ludlow 42-BIC Coronet Bold

Characters in Complete Font

A B C D E F G

H I J K L M N

O P Q R S T U

V W X Y Z & \$

1 2 3 4 5 6 7 8 9 0

a b c d e f g h i j k l m n

o p q r s t u v w x y z

. : , ; - ' ' ! ? - () []

Characters listed below sold separately

F T J %

For fractions see fraction specimen pages

Special Ludlow DISPLAY casting: 14, 18, 24, 30, 36, 48

Florentine Cursive (Ludlow #52-LIC) SE

Designed by Middleton for Ludlow in 1956.

*A Source Of Supply Of Durable
italic in any quantity is available with
the Ludlow system of slug composition
as well as attractiveness and efficiency*

18 Point Ludlow 52-LIC Florentine Cursive
Length of lower-case alphabet: 128 points

Characters in Complete Font

A B C D E F G H I J K L M N O

P Q R S T U V W X Y Z &

a b c d e f g h i j k l m n o p q r s t u v

w x y z

. : , ; - ' " ! ? () [] - \$ 1 2 3 4 5 6 7 8 9 0

Special Ludlow DISPLAY casting: 14, 18

Formal Script (Ludlow #51-MIC) ^{SE}

Derivative of *Typo Script*, by Middleton in 1956.

America Proudly Hails Queen of England

18 Point Ludlow 51-MIC Formal Script

Characters in Complete Font

A B C D E F G H I J K L M N O

P Q R S T U V W X Y Z

abcdefghijklmnopqrstuvwxyz

*! " # \$ % & ' () * + , - . : ; =*

0 1 2 3

Special DISPLAY casting: 18, 24

Futura — see Twentieth Century this section

Gill Sans (English Monotype) #262

Created by Eric Gill c. 1929, perhaps based on Edward Johnson's face for the London Underground. Johnson was Gill's teacher and friend.

ABCDEFGHIJKLMNOPQRSTUVWXYZ&ÆŒ

ABCDEFGHIJKLMNOPQRSTUVWXYZ&

abcdefghijklmnopqrstuvwxyzfiflffiffllæœ

ABCDEFGHIJKLMNOPQRSTUVWXYZ&ÆŒ

abcdefghijklmnopqrstuvwxyzfiflffiffllæœ

1234567890 .,:;!?'-([†‡\$€\$*-)\$€\$†‡])-'?!;:, 1234567890

Roman & Italic: Composition 6 (6D), 8 (8D), 10 (10D), 12 (11D)

Gill Sans Bold (English Monotype) #275

ABCDEFGHIJKLMNOPQRSTUVWXYZ

abcdefghijklmnopqrstuvwxyziiflffiffllæœ

ABCDEFGHIJKLMNOPQRSTUVWXYZ&ÆCE

abcdefghijklmnopqrstuvwxyziiflffiffllæœ

1234567890 &ÆCE 1234567890

.,:;!?"-([†\$£\$*—\$£\$‡†])-“‘?!;:,

Roman: Composition: 6 (6D), 8 (8D), 10 (10D), 12 (11D)

Gill Sans Shadow (English Monotype) #406

ABCDEFGHIJKLMNOPQRSTUVWXYZ&ÆCE

£1234567890 .,:;!?"-([†\$£\$*—

ALTERNATIVE CHARACTER **R**₃₃₄

Display: 24

Gill Sans Titling Shadow (English Monotype) #304

ABCDEFGHIJKLMNOPQRSTUVWXYZ&ÆCE

£1234567890

ALTERNATIVE CHARACTER

R₁₉₉

.,:;!?"-([†\$£\$*—

Display: 18, 24

Granby Inline (Stephenson & Blake)

THE QUICK BROWN fox jumps at !

DISPLAY: Roman: 18, 30, 36, 48
(Thompson Electroplated Mats)

Greeting Monotone (Intertype)

By Morris Benton of ATF in 1927.

ABCDEFGHIJKLMNOPQRSTUVWXYZ abcdefgh
ijklmnopqrstuvwxyz ,:;'"\$&-?(!) 1234567890

Special DISPLAY casting: 10, 12, 14, 18

Grotesque (English Monotype) #215

Released in 1926, based on German types.

ABCDEFGHIJKLMNOPQRSTUVWXYZ&ÆŒ

abcdefghijklmnopqrstuvwxyziiflffffiffllæœ

ABCDEFGHIJKLMNOPQRSTUVWXYZ&ÆŒ

abcdefghijklmnopqrstuvwxyziiflffffiffllæœ

1234567890 .,:;!?''-([†‡§£\$*—\$£§‡†])-''?!;:,. 1234567890

Roman & Italic: Composition: 5 (5D), 6.5 (6D), 7.5 (7D), 8 (8D), 9 (8D large),
10 (9D), 11 (10D), 13 (12D)

DISPLAY: Roman: 18D (20pt), 30D (36 pt small), 36D (36 pt large)

Grotesque Bold (English Monotype) #216

ABCDEFGHIJKLMNOPQRSTUVWXYZ&ÆŒ

abcdefghijklmnopqrstuvwxyziiflffffiffllæœ

ABCDEFGHIJKLMNOPQRSTUVWXYZ&ÆŒ

abcdefghijklmnopqrstuvwxyziiflffffiffllæœ

1234567890 1234567890

.,:;!?''-([†‡§£\$*—\$£§‡†])-''?!;:,.

Roman Composition: 5 (5D), 6.5 (6D), 7.5 (7D), 8 (8D), 9 (8D large),
10 (9D), 11 (10D), 13 (12D) See casting note for #126, Grotesque Light
DISPLAY: Roman: 14D (16 pt), 18D (20 pt), 24D (30 pt), 30D (36 pt small),
36D (36 pt large)

Grotesque Light (English Monotype) #126

ABCDEFGHIJKLMNOPQRSTUVWXYZ&ÆŒ

abcdefghijklmnopqrstuvwxyzfiflffiffllæœ

ABCDEFGHIJKLMNOPQRSTUVWXYZ&ÆŒ

abcdefghijklmnopqrstuvwxyzfiflffiffllæœ

1234567890 .,:;!?''-([†‡§£\$*—\$£\$†‡])-'?!;:,. 1234567890

Roman Composition: 5 (5 Didot), 6.5 (6D), 7.5 (7D), 8 (8D small), 9 (8D large), 10 (9D), 11 (10D), 13 (12D)

(NOTE: odd sizes can be cast on even bodies, e.g. 12D on 14 (English) point body, and 9 pt on 10, or 11 pt on 12 pt body, etc)

DISPLAY: Roman: 14D on 16 English points body, 18D on 20, 24D on 30, 30D on 36, 36D on 36

Grotesque No. 2, (English Monotype) #51

ABCDEFGHIJKLMNOPQRSTUVWXYZ&ÆŒ

abcdefghijklmnopqrstuvwxyzfiflffiffllæœ

1234567890 .,:;!?''-([†‡§£\$*—

Large Composition Roman: 14 (14D), 18 (18D), 24 (24D)

Hauser Script (Ludlow)

By George Hauser in 1936.

Characters in Complete Font

A B C D E F G H
I J K L M N O P Q
R S T U V W
X Y Z &
\$ 1 2 3 4 5 6 7 8 9 0
a b c d e f g h i j k
l m n o p q r s t
u v w x y z
. : , ; - ' ! ? () [] - ~

Characters listed below sold separately

$\frac{1}{4}$ $\frac{1}{3}$ $\frac{1}{2}$ $\frac{2}{3}$ $\frac{3}{4}$
F T %

Murray Shops 12
Build new presses
for better printing
in newspaper field

30 Point Ludlow 38-HIC Hauser Script
Length of lower-case alphabet: 265 points

DISPLAY: 18, 24, 36, 48 Special Ludlow Casting

Helvetica #496

By Max Miedinger & Edward Hoffman for Haas Typefounders in Switzerland c. 1957 and called *Neue Hass Grotesk*, then acquired by Stemple.

ABCDEFGHIJKLMNOPQRSTUVWXYZ &
abcdefghijklmnopqrstuvwxyz f i l f f f i f f l

ABCDEFGHIJKLMNOPQRSTUVWXYZ &
abcdefghijklmnopqrstuvwxyz f i l f f f i f f l

\$1234567890 \$1234567890

.,-':;!?()*- / .,-':;!?(*)

6, 7, 8, 9, 10, 11, 12 Roman & Italic Composition

Helvetica Medium #508

ABCDEFGHIJKLMNOPQRSTUVWXYZ &
abcdefghijklmnopqrstuvwxyz f i l f f f i f f l

\$1234567890 .,-':;!?()*- /

6, 7, 8, 9, 10, 11, 12 Roman Composition

Kabel: see Sans Serif this section

Kino #305 (English)

Designed in 1930 by Martin Dovey for the Monotype Corporation.

SYNOPSIS IN 18 POINT

ABCDEFGHIJKLMNOPQRSTUVWXYZ & Æ Æ

abcdefghijklmnopqrstuvwxyz æ œ

£1234567890 .,:;!?'-[†§*—

DISPLAY: 18

Lydian (Intertype) By Warren Chappell for ATF c.1938.

INTERTYPE matrices excel in type 12345

INTERTYPE matrices excel in type 12345

Roman & Italic DISPLAY special casting: 10, 12, 14, 18, 24, 30, 36

Lydian Bold (Intertype)

INTERTYPE matrices excel in typ 12345

INTERTYPE matrices excel in typ 12345

Roman and Italic DISPLAY special casting: 12, 14, 18, 24, 30, 36

Mandate (Ludlow) By R.H. Middleton c. 1934 for Ludlow.

*New Rates 38
On insurance
in September*

30 Point Ludlow 36-BIC Mandate
Length of lower-case alphabet: 350 points

*Fortune Made 46
By farmer after
striking rare ore*

24 Point Ludlow 36-BIC Mandate
Length of lower-case alphabet: 262 points

*Leading Department 85
Store to hire more help
for new suburban store*

18 Point Ludlow 36-BIC Mandate
Length of lower-case alphabet: 192 points

*Satisfied Users Demand 63
Dynamic faces of the latest
creation in all their display
having a new informal tone*

14 Point Ludlow 36-BIC Mandate
Length of lower-case alphabet: 157 points

Italic DISPLAY special casting: 18, 24, 30, 36, 48

Mayfair Script (Ludlow) 30SE By Middleton c.1932 for Ludlow

Characters in Complete Font

A B C D E F G

H I J K L M N

O P Q R S T U

V W X Y Z & \$

1 2 3 4 5 6 7 8 9 0

a b c d e f g h i j k l m n

o p q r s t u v w x y z

. : , ; - ' ' ! ? () [] -

Characters listed below sold separately

F Q J %

Italic DISPLAY special casting: 18, 24, 30

Parisian (Intertype)

Designed by Morris Benton of ATF in 1928.

*A B C D E F G H I J K L M N O P Q R S T U V W X Y Z & \$ 1 2
3 4 5 6 7 8 9 0 . , ; - () ' ? ! a b c d e f g h i j k l m n o p q r s t u v w x y z a b c d e f g h*

Special DISPLAY casting: 10, 12, 14, 18

Park Avenue (Intertype)

Designed by Robert E. Smith for ATF c. 1933.

*A B C D E F G H I J K L M N O P Q
R S T U V W X Y Z & \$ 1 2 3 4 5 6 7 8 9 0 . , - ' ! ?
a b c d e f g h i j k l m n o p q r s t u v w x y z rs es er*

Special DISPLAY casting: 12, 14, 18 (accents 12 & 14 & 18)

Pepita (English Monotype) # 613

Designed by Imre Reiner c. 1959

ABCDEF GHIJKLMNOP
QRSTUVWXYZ & AÆ
abcdefghijklmnopqrstu vwxyz fi fl ff fi fl aæ

£1234567890 q⁶³⁷

.,:;!?'-()[]+& \$%/*«"”-

DISPLAY: 42 Didot on 48 pt. English

Pilot Black Italic

24 pt (Caps, figures, punctuation)

This unique design by Aleksandra Samulenkova won the Fine Press Book Association's Type Design Contest of 2013. The face was engraved and cast by Swamp Press for the FPBA. Due to the tight fit and extensive overhangs the casting is arduous and the type must be hand finished.

Thus fonts run \$140 each (plus shipping).

ABCDEFGHIJKLMN OPQRSTUVWXYZ&

1234567890 .,:;'()[]?!/

Reverse (Ludlow)

ABCDEFGHIJKLMN OPQRSTUVWXYZ&

1234567890

▲ ▼ ▶ ◀ ▶ ◀ ▶ ◀ ▶

DISPLAY special casting: 18

Sans Serif Light #329
aka Monotype Sans Serif Light
aka Kabel

Derived from Rudolph Koch's *Kabel* aka *Cable* of the 1920's German typefaces stressing clean lines and a monotone weight.

ABCDEFGHIJKLMNOPQRSTUVWXYZ &
 abcdefghijklmnopqrstuvwxyz fi fl ff
 \$1234567890 . , - ' ; ! ? « » (

Display — 12 to 24 Point, 78 Characters; 30 to 72 Point, 76; 72H4 Point, 52 Characters.

VARIANT CHARACTERS FOR USE WITH THIS SERIES

(May be substituted for regular characters when ordering fonts or purchased separately)

AJWY a e g j t u

329-H91—Available in all Display sizes
 from 14 Point No. 2 to 72 Point.

A E F K M N R S W e k s

329-H92—Available in all Display sizes
 from 14 Point No. 2 to 72 Point.

ABDEFGHJLMPQRSU

329-H93—Available in all Display sizes from 24 Point to 72 Point.

ABCDEFGHIJKLMNOPQRSTUVWXYZ &

abcdefghijklmnopqrstuvwxyz

\$1234567890 « » () . , - ' ; ! ?

Special Arrangement

Composition—6 to 12 Point, 77 Characters

Display—14 to 72 Point, 76 Characters

Can be combined for Machine Typesetting with Sans Serif Light or Sans Serif Bold Italic

VARIANT CHARACTERS FOR USE WITH THIS SERIES

(May be substituted for regular characters when ordering fonts or purchased separately)

A C G W a b e g j t u

329K-H91—Available in all composition sizes from 6 to 18 Point

Roman & Italic Composition: 6, 8, 10, 12 + accents

DISPLAY: Roman: 14, 14#2, 18, 24, 30, 36, 42, 48, 60, 72

Italic: 14, 18, 24, 30, 36, 42, 48, 60, 72

H-91 Alts: Rom: 14, 14#2, 18, 24, 30, 36

H-92 Alts: Roman: 14#2, 18, 24, 30, 36

Sans Serif Light Condensed #357

A B C D E F G H I J K L M N O P Q R S T U V W X Y Z &
a b c d e e f g g h i j k l m n o p q r s t t u u v w x y z
\$ 1 2 3 4 5 6 7 8 9 0 \$ ¢ . , - ' : ; ! ? (

DISPLAY: Roman: 18, 24, 30, 36, 72

Sans Serif Lined #430

SAILING FROM NEW YORK ON THE STEAMER
MALMONT TO ALL POINTS & . , - ' : ; ! ? \$ 1 2 3 4 5 6 7 8 9 0

DISPLAY: 24, 30, 36

Sans Serif Medium #331

A B C D E F G H I J K L M N O P Q R S T U
V W X Y Z &
a b c d e f g h i j k l m n o p q r s t u v w x y z fi fl ff
\$ \$ 1 1 2 3 4 5 6 7 8 9 0 « » (. , - ' : ; ! ?

Display -14 to 72 Point, 81 Characters

VARIANT CHARACTERS FOR USE WITH THIS SERIES

(May be substituted for regular characters when ordering fonts or purchased separately)

A J W Y a e g j t u

331-H91 - Available in all Display sizes
from 14 to 72 Point

A E F K M N R S W e k s

331-H92 - Available in all Display sizes
from 14 to 36 Point

Roman Composition: 6, 8, 10, 12,

Large Composition Roman: 14, 18

DISPLAY: Roman: 14, 18, 24, 30, 36, 42, 48, 60, 72

H-91 Alternates, Roman: 14

Sans Serif Medium Condensed #354

A B C D E F G H I J K L M N O P Q R S T

U V W X Y Z &

a b c d e e f g g h i j k l m n o p q r s t t u u v w x y z

\$ 1 2 3 4 5 6 7 8 9 0 \$ ¢ . , - ' ' : ; ! ? (

DISPLAY: Roman: 14, 18, 24, 30, 36, 48, 60, 72

Linotype mats with slugs showing border and type. Note that since the casting is in the form of a slug it cannot be corrected easily. Usually the whole line (slug must be recast. Also, since the mats sit side by side, there can be no kerned characters. Linotype solved this problem by making logotypes, or mats with multiple characters. Intertype and Linotype mats can run on either Intertype or Linotype machines and are virtually identical except for their manufacturers.

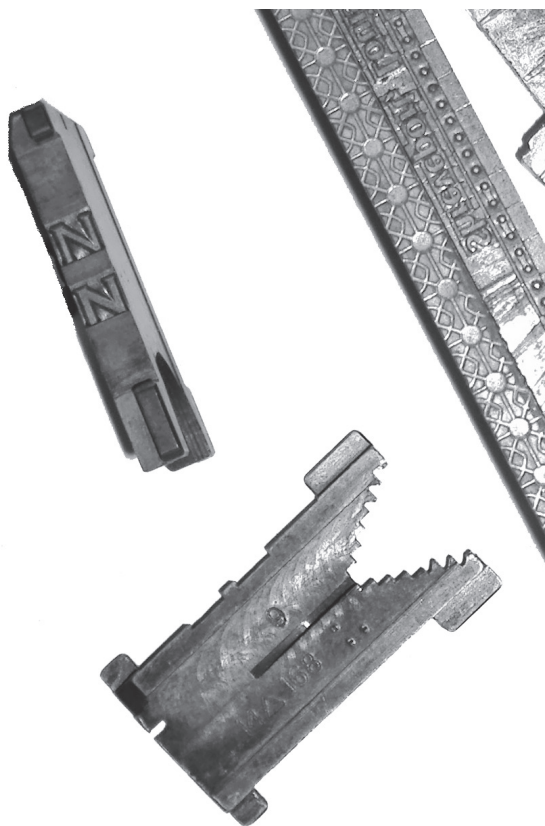

Sans Serif Bold #330

A B C D E F G H I J K L M N O P Q R S
T U V W X Y Z &

a b c d e f g h i j k l m n o p q r s t u v w x y z fi fl ff

\$ 1 2 3 4 5 6 7 8 9 0 . , - ' ; ! ? « » (♦ € £ ¤

Display — 12 and 14 Point No. 1, 82 Characters; 14 Point No. 2 to 24 Point, 84; 30 and 36 Point, 82; 42 to 72 Point, 76; 72H4 Point, 52 Characters

VARIANT CHARACTERS FOR USE WITH THIS SERIES

(May be substituted for regular characters when ordering fonts or purchased separately)

A J W Y a e g i t u

330-H91 — Available in all Composition and Display sizes from 6 to 72 Point

A E F K M N R S W e k s

330-H92 — Available in all Display sizes from 14 to 36 Point

C E F G H f i j r s t

330-H9 — Available in all Display sizes from 18 to 72 Point

A B C D E F G H I J K L M N O P Q R S T U V W X Y Z &

a b c d e f g h i j k l m n o p q r s t u v w x y z

\$ 1 2 3 4 5 6 7 8 9 0 . , - ' ; ! ? (« »

Special Arrangement

Composition — 6 to 12 Point, 77 Characters; Display — 14 to 72 Point, 75 Characters
Can be combined for Machine Typesetting with Sans Serif Bold or Sans Serif Light Italic

VARIANT CHARACTERS FOR USE WITH THIS SERIES

(May be substituted for regular characters when ordering fonts or purchased separately)

A C G W a b e g i t u

330K-H91 — Available in all Composition and Display sizes from 6 to 72 Point

Roman & Italic Composition: 6, 8, 10, 12, Large Composition Roman: 14, 18

DISPLAY: Roman: 14, 14#2, 18, 24, 30, 36, 42, 48, 60, 72

Italic: 14, 18, 24, 30, 36, 42, 48, 60, 72

H-91 Alts: Roman: 14#2, 18, 24, 30, 36

Italic: 14, 14#2, 18, 24, 30, 36

H-92 Alts: Roman: 14#2, 18, 24, 30, 36

H-9 Alts: Roman: 18, 24, 30, 36(inc)

Sans Serif Extrabold (Hess) #332

CHARACTERS IN FONTS

A B C D E F G H I J K L M N O P Q R S T U V W X Y Z &

a b c d e f g h i j k l m n o p q r s t u v w x y z fi fl ff

\$ 1 2 3 4 5 6 7 8 9 0 . , - ' : ; ! ? (« »

Special Arrangement

Composition — 6 to 12 Point, 80 Characters

Display — 12 to 72 Point, 80 Characters; 72H4 Point, 50 Characters

Can be combined for Machine Typesetting with Sans Serif Extrabold Italic, Sans Serif Medium or Sans Serif Bold

VARIANT CHARACTERS FOR USE WITH THIS SERIES

(May be substituted for regular characters when ordering fonts or purchased separately)

A J Y a e g j t u

332-H91 — Available in all Composition and Display sizes from 8 to 72 Point

A B C D E F G H I J K L M N O P Q R

S T U V W X Y Z &

a b c d e f g h i j k l m n o p q r s t u v

w x y z fi fl ff

\$ 1 2 3 4 5 6 7 8 9 0 . , - ' : ; ! ? (« »

Roman Composition: 6, 8, 10, 12

DISPLAY: Roman: 14, 18, 24, 30, 36, 42, 48, 60, 72

Italic: 14, 18, 24, 30, 36, 72

H-91 ALTS: Roman: 14, (18, 24, 36 inc)

Sans Serif Extrabold Condensed # 333

A B C D E F G H I J K L M N O P Q R

S T U V W X Y Z &

a a b c d e e f f g g h i j k l m n o p q

r s t t u u v w x y z

\$ 1 2 3 4 5 6 7 8 9 0 \$ ¢ . , - ' : ; ! ?)

DISPLAY: Roman: 18, 24, 30, 36, 48, 60, 72

Script Bold #322 (English)

Designed by Monotype Design Studio in 1931

SYNOPSIS IN 14 POINT

A B C D E F G H I J K L M N O P Q R S T U V
W X Y Z & Æ Œ

abcdefghijklmnopqrstuvwxyzææfiflfflfflffl

£1234567890 .,:;!?'-(+\$*-* ALTERNATIVE CHARACTERS
199 p 381 s 452 T

DISPLAY: 14, 18, 24, 36

Shadow (Intertype)

Designed by Morris Benton of ATF in 1934.

INTERTYPE MATRICES
EX 123

Special DISPLAY casting: 14 (#2103)

Stellar (Ludlow)

Designed by Middleton in 1929 for Ludlow.

GARDEN CLUBS WILL 49
Hold the annual joint meeting
to choose grand prize winner

18 Point Ludlow 27-L Stellar

Characters in Complete Font

A B C D E F G H I J

K L M N O P Q R S T

U V W X Y Z &

\$ 1 2 3 4 5 6 7 8 9 0

a b c d e f g h i j k l m n

o p q r s t u v w x y z

. : , ; - ' ' ! ? [] () - +

Characters listed below sold separately

A E H U %

Special DISPLAY casting: 14, 18, 24

Stylescript #425

Designed by Sol Hess for Lanston in 1940.

A B C D E F G H I J K L M N O P Q R S
T U V W X Y Z &
a b c d e f g h i j k k l m n o p q r r s s
t u v w x y z
\$ 1 2 3 4 5 6 7 8 9 0 . , - ' : ; ! ?

DISPLAY: 14, 18, 24, 30, 36

Swing Bold #217

Designed by Monotype Design Studio (Lanston) Max R. Kaufmann in 1936

A B C D E F G H I J K L M N O P Q R S T
U V W X Y Z &
a b c d e f g h i j k l m n o p q r s t u u
w x y z
\$ 1 2 3 4 5 6 7 8 9 0 . , - ' " ' " : ; ! ? , &

Display Italic: 14, 18, 24, 30, 36, 42, 48, 60, 72

Twentieth Century Extrabold #603 aka Futura

Lanston's copy of Futura, based on the design by Paul Renner for Bauer Typefoundry in Germany c. 1927, using the Bauhaus aesthetics. The face was called the "most influential face of its era". Baltotype did the first pirated version "Airport" c. 1943; Sol Hess of Lanston did some versions as well.

ABCDEFGHIJKLMNOPQRSTUVWXYZ&

abcdefghijklmnopqrstuvwxy *fifff*

\$1234567890 .,-'":;!?()-%

ABCDEFGHIJKLMNOPQRSTUVWXYZ&

abcdefghijklmnopqrstuvwxy *fifff*

\$1234567890 .,-'":;!?()

Roman & Italic Composition: 6, 8, 9, 10, 11, 12;

Roman Large Composition: 14, 18

DISPLAY: Roman: 14, 16, 18, 24, 30, 36, 42, 48, 72

Italic: 14, 16, 18, 24, 30, 36, 42, 48, 60, 72

Twentieth Century Bold #604

ABCDEFGHIJKLMNOPQRSTUVWXYZ&

abcdefghijklmnopqrstuvwxy *fifff*

\$1234567890 .,-'":;!?()

ABCDEFGHIJKLMNOPQRSTUVWXYZ&

abcdefghijklmnopqrstuvwxy *fifff*

\$1234567890 .,-'":;!?()

Roman & Italic Composition: 6, 7, 8, 9, 10, 11, 12

DISPLAY: Roman: 14, 16, 18, 24, 30, 36, 42, 48, 60, 72

Italic: 14, 16, 18, 24, 30, 36, 42, 48, 60, 72

Twentieth Century Medium #605

ABCDEFGHIJKLMNOPQRSTUVWXYZ&

abcdefghijklmnopqrstuvwxy *fi*ff

\$1234567890 .,-'":;!?()

ABCDEFGHIJKLMNOPQRSTUVWXYZ&

abcdefghijklmnopqrstuvwxy *fi*ff

\$1234567890 .,-'":;!?()

Roman & Italic Composition: 6, 7, 8, 9, 10, 11, 12, + accents

Roman Large Composition 14, 18

DISPLAY: Roman: 14, 16, 18, 24, 30, 36, 42, 48

Italic: 14, 16, 18, 24, 30, 36

Twentieth Century Light #606

ABCDEFGHIJKLMNOPQRSTUVWXYZ&

abcdefghijklmnopqrstuvwxy *fi*ff

\$1234567890 .,-'":;!?()

ABCDEFGHIJKLMNOPQRSTUVWXYZ&

abcdefghijklmnopqrstuvwxy *fi*ff

\$1234567890 .,-'":;!?()

Roman & Italic Composition: 6, 8, 9, 10, 12;

Roman Large Composition: 18

DISPLAY: Roman: 14, 16, 18, 24, 30, 36, 60, 72

Italic: 14, 18, 24, 30, 36

20th Century Extrabold Condensed #607

ABCDEFGHIJKLMNOPQRSTUVWXYZ&

abcdefghijklmnopqrstuvxyz fi fl ff

\$1234567890 .,-'":;!?()

ABCDEFGHIJKLMNOPQRSTUVWXYZ&

abcdefghijklmnopqrstuvxyz fi fl ff

\$1234567890 .,-'":;!?()

Roman & Italic Composition: 8, 10, 12

DISPLAY: Roman: 14, 16, 18, 24, 30, 36, 42, 48 (T), 60, 72, 72H4

Italic: 14, 16, 18, 24, 30, 36, 42, 48, 60, 72, 72H4

Twentieth Century Medium Condensed #608

A B C D E F G H I J K L M N O P Q R S T U V

W X Y Z &

a b c d e f g h i j k l m n o p q r s t u v

w x y z fi fl ff

\$1234567890 .,-'":;!?()

ABCDEFGHIJKLMNOPQRSTUVWXYZ&

abcdefghijklmnopqrstuvxyz fi fl ff

\$1234567890 .,-'":;!?()

Roman Composition: 8, 10, 12,

DISPLAY: Roman: 14, 16, 18, 24, 30, 36, 42, 60, 72

Italic: 14, 18, 30, 36

Twentieth Century Ultrabold #609

ABCDEFGHIJKLMNOPQRSTUVWXYZ &

abcdefghijklmnopqrstuvwxyz fi fl ff

\$1234567890 .,-“”:;!?(%)

ABCDEFGHIJKLMNOPQRSTUVWXYZ &

abcdefghijklmnopqrstuvwxyz fi fl ff

\$1234567890 .,-“”:;!?(%)

Roman Composition: 8, 9, 10, 11, 12,

Italic Composition: 8, 10, 12

DISPLAY: Roman: 14, 16, 18, 24, 30, 36, 42, 60, 72

Italic: 14, 18, 24, 30, 36, 42, 48, 72

20th Century Ultrabold Condensed #610

ABCDEFGHIJKLMNOPQRSTUVWXYZ &

abcdefghijklmnopqrstuvwxyz fi fl ff

\$1234567890 .,-“”:;!?(%)

A B C D E F G H I J K L M N O P Q R S T

U V W X Y Z &

a b c d e f g h i j k l m n o p q r s t u v w

x y z fi fl ff

\$1234567890 .,-“”:;!?(%)

Roman Composition: 8, 10, 12

DISPLAY: Roman: 14, 18, 24, 30, 36, 42, 60, 72

Italic: 14, 16, 18, 24, 30, 36, 42, 48

Twentieth Century Ultrabold Extended #614

A B C D E F G H I J K L M N O P Q
R S T U V W X Y Z &
a b c d e f g h i j k l m n o p q r s
t u v w x y z ff fi fl
\$ 1 2 3 4 5 6 7 8 9 0
. , - ' " : ; ! ? () %

DISPLAY: 14, 18, 24, 30, 36, 42, 48

Umbra (Ludlow) (R.H. Middleton for Ludlow 1932)

EXCELS IN 43
SLUG FORMS

48 Point Ludlow No. 34 Umbra

Special DISPLAY casting: 18, 30, 48

Characters in Complete First

A	B	C	D
E	F	G	H
I	J	K	L
M	N	O	P
Q	R	S	T
U	V	W	X
Y	Z	&	\$
1	2	3	4
5	6	7	8
9	0	.	,
'	"	:	;
!	?	+	-

Characters listed below will separate

() []

Univers is the name of a large sans-serif typeface family designed by Adrian Frutiger and released by his employer Deberny & Peignot in 1957. Frutiger came out of the Swiss International Style of typography, mentored by Ernst Keller at the School of Applied Arts in Zurich. Released in 1961 by Monotype.

Univers: NOTE: all sizes are given in Didot points. The Deberny & Peignot designation is in parentheses.

Also: 5 Didot Points = 6 Points English; 6D=7; 7D=8; 8D=9; 8.5D=9; 9D=10; 10D=11; 11D=12; 12D=13; 14D=16; 16D=18; 18D=20; 22D=24; 28D=30; 36D=36; 48D=60

Univers Light (English Monotype) #685

(Deberny & Peignot #45,46)

ABCDEFGHIJKLMNOPQRSTUVWXYZ&ÆŒ

abcdefghijklmnopqrstuvwxyzæœ

ABCDEFGHIJKLMNOPQRSTUVWXYZ&ÆŒ

abcdefghijklmnopqrstuvwxyzæœ

1234567890 1234567890

& s16511 .,:;!?'-([†‡§£\$*—\$£§††])-“?;!;:.. s16512 &

Roman & Italic Composition: 5, 6, 7, 8, 8.5, 9, 10, 11, 12 Didot

DISPLAY: Roman: 14, 18, 22, 28, 36, 48 Didot

Italic: 14, 16, 18, 22, 28, 36, 48 Didot

Univers Light Condensed #686

(Deberny & Peignot #47,48)

ABCDEFGHIJKLMNOPQRSTUVWXYZ&ÆŒ

abcdefghijklmnopqrstuvwxyzæœ

ABCDEFGHIJKLMNOPQRSTUVWXYZ&ÆŒ

abcdefghijklmnopqrstuvwxyzæœ

1234567890 1234567890

& S16511

.,:;!?"'-([†‡§£\$*—\$£\$†])-'?!;:..

S16512 &

Roman & Italic Composition: 6, 8, 9, 10, 12 Didot

DISPLAY: Roman: 16, 22, 28, 36, 48 Didot

Italic: 14, 16, 18, 22, 28, 36, 48 Didot

Univers Medium Expanded #688

(Deberny & Peignot #53)

ABCDEFGHIJKLMNOPQR

STUVWXYZ&ÆŒ

abcdefghijklmnopqrstuvwxyzæœ

1234567890 .,:;!?"'-([†‡§£\$*—

& S16511

DISPLAY: Roman: 14, 28, 36, 48 Didot

Univers Medium #689

(Deberny & Peignot #55,56)

ABCDEFGHIJKLMNOPQRSTUVWXYZ&ÆŒ

ABCDEFGHIJKLMNOPQRSTUVWXYZ&ÆŒ

abcdefghijklmnopqrstuvwxyæœ

ABCDEFGHIJKLMNOPQRSTUVWXYZ&ÆŒ

abcdefghijklmnopqrstuvwxyæœ

1234567890 1234567890

.,:;!?"-([†‡§£\$*—\$£§†‡])-“?;!;:..

& S16511 & S16512 & S19710

Upright & Sloped Composition : 6, 8, 8.5, 9, 10, 11, 12 + accents Didot

Upright only: 7

DISPLAY: Roman: 14, 16, 18, 22, 28, 36, 48 Didot

Italic: 18, 22, 28, 36, 48 Didot

(11D italic is Linotype #12Δ147)

Note: All the Univers is English Monotype, except as noted.

Univers Medium Condensed #690

(Deberny & Peignot #57,58)

ABCDEFGHIJKLMNOPQRSTUVWXYZ&ÆŒ

abcdefghijklmnopqrstuvwxyæœ

ABCDEFGHIJKLMNOPQRSTUVWXYZ&ÆŒ

abcdefghijklmnopqrstuvwxyæœ

1234567890 1234567890

& S16511 .,:;!?"-([†‡§£\$*—\$£§†‡])-“?;!;:.. S16512 &

Roman & Italic Composition: 6, 8, 9, 10, 12 Didot

DISPLAY: Roman: 14, 16, 18, 22, 28, 36, 28, 36, 48 Didot

Italic: 14, 18, 22, 28, 36, 48 Didot

Univers Medium Extra Condensed #691

(Deberny & Peignot #59)

ABCDEFGHIJKLMNOPQRSTUVWXYZÆŒ

abcdefghijklmnopqrstuvwxyzæœ

1234567890

.,:;!?"-([†‡§£\$*—

& S16511

DISPLAY: Roman: 36, 48 Didot

Univers Bold #693

(Deberny & Peignot #65, 66)

ABCDEFGHIJKLMNOPQRSTUVWXYZ&ÆŒ

abcdefghijklmnopqrstuvwxyzæœ

ABCDEFGHIJKLMNOPQRSTUVWXYZ&ÆŒ

abcdefghijklmnopqrstuvwxyzæœ

1234567890 1234567890

& S16511 .,:;!?"-([†‡§£\$*—\$£§††])-“? !;:.. S16512 &

Roman & Italic Composition: 6, 7, 8, 8.5, 9, 10, 11, 12 Didot

DISPLAY: Roman: 18, 22, 28 Didot

Italic: 14, 18, 22, 28, 36 Didot

Univers Bold Condensed #694

(Deberny & Peignot #67,68)

ABCDEFGHIJKLMNOPQRSTUVWXYZ&ÆŒ

abcdefghijklmnopqrstuvwxyzæœ

ABCDEFGHIJKLMNOPQRSTUVWXYZ&ÆŒ

abcdefghijklmnopqrstuvwxyzæœ

1234567890 1234567890

& S16511 .,:;!?"-([†‡§£\$*—\$£\$††])-“”?!;:,. S16512 &

Roman & Italic Composition: 6, 8, 9, 10, 12, Didot

DISPLAY: Roman: 14, 18, 22, 28, 36 Didot

Italic: 14, 18, 22, 26, 36 Didot

Univers Extra Bold #696

(Deberny & Peignot #75,76)

ABCDEFGHIJKLMNOPQRSTUVWXYZ&ÆŒ

abcdefghijklmnopqrstuvwxyzæœ

ABCDEFGHIJKLMNOPQRSTUVWXYZ&ÆŒ

abcdefghijklmnopqrstuvwxyzæœ

& S16511 1234567890 1234567890 S16512 &

.,:;!?"-([†‡§£\$*—\$£\$††])-“”?!;:,. S16512 &

Roman & Italic Composition: 6, 7, 8, 8 1/2, 9, 10, 11, 12 Didot

DISPLAY: Roman: 14, 16, 18, 22, 28, 36, 48 Didot

Italic: 14, 16, 18, 22, 28, 36, 48 Didot

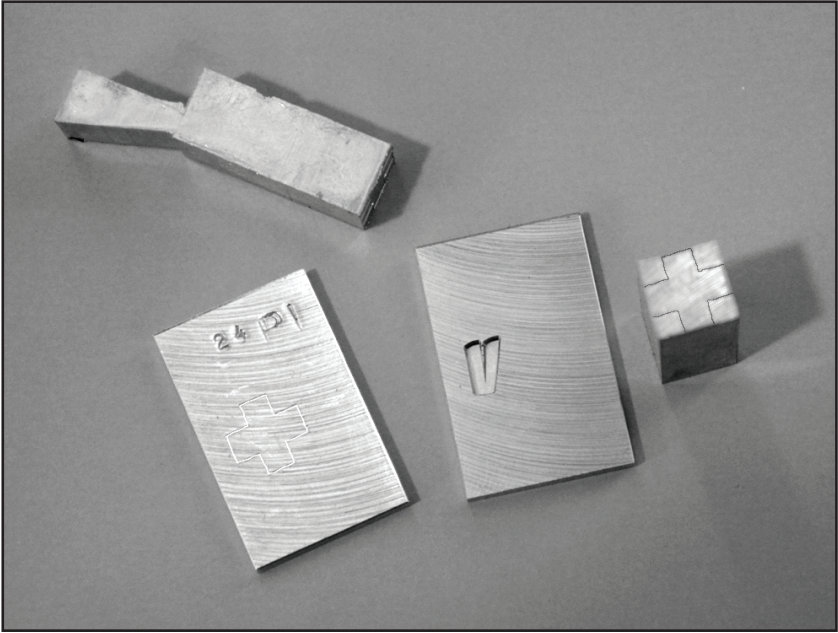

Engraved *Pilot* matrix with positioning “cross matrix” and the cross type with and with the jet.

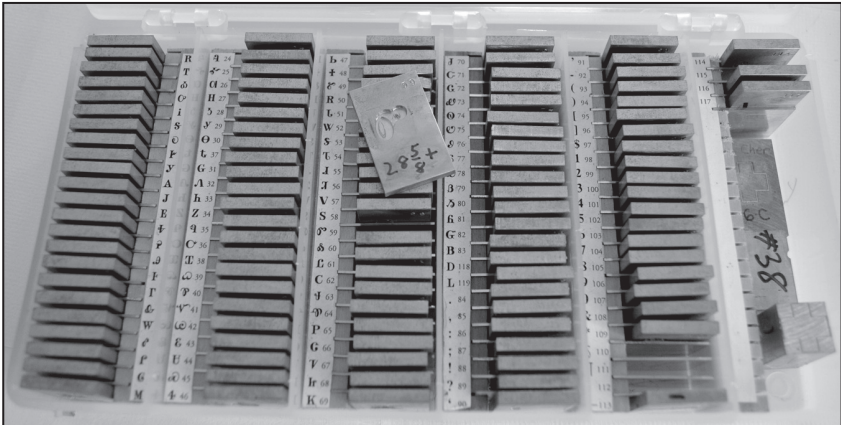

Matrix box with a full suite of Cherokee matrices. The marking at the bottom of the mat is the set, or width in points, of the cast type.

Valiant (Shaar) #412

By Edwin W. Shaar for Lanston Monotype in 1940.

A B C D E F G H I J K L M N O P Q R S T
U V W X Y Z &
a b c d e f g g h i j k k l m n o p q r s t u
v w x y z
\$ 1 2 3 4 5 6 7 8 9 0 \$ ¢ % . , - ' " " : ; ! ? - ()

DISPLAY: Roman: 14, 18, 24, 30, 36, 48

Wave (Ludlow)

(R.H. Middleton for Ludlow 1962)

& A B C D E F G H I J K
L M N O P Q R S T U V W X Y Z
a b c d e f g h i j k l m n o p q r s t u v w x y z
.,;,-'!?() [] - · 1 2 3 4 5 6 7 8 9 0 \$

Special DISPLAY: Roman: 30

III. GOTHICS

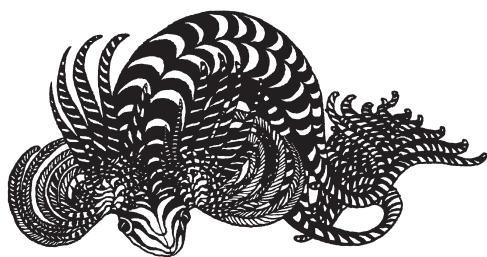

SWAMP PRESS

Alternate Gothic Condensed No. 3 — #177

By Morris Benton in 1903, based on earlier Gothics, and made for Lanston
by Sol Hess,

A B C D E F G H I J K L M N O P Q R S
T U V W X Y Z &
a b c d e f g h i j k l m n o p q r s t u
v w x y z
\$ 1 2 3 4 5 6 7 8 9 0 . , - ' : ; ! ?

DISPLAY: Roman: 14, 18, 24, 30, 36

Alternate Gothic No. 1 — #51

ABCDEF GHIJKLMNOPQRSTUVWXYZ & Æ Æ
abcdefghijklmnopqrstuvwxyzæ æ fiflffffiffl
\$1234567890 .,-“”:;!?

Roman: Composition 6, 8, 10, 12

DISPLAY: 14, 18, 24, 30, 36, 36H4, 42, 48, 60, 72, 72H4

Alternate Gothic No.2 — #77

A B C D E F G H I J K L M N O P Q R S T U

V W X Y Z & Æ Œ

a b c d e f g h i j k l m n o p q r s t u v w x y z

æ œ fi fl ff

\$ 1 2 3 4 5 6 7 8 9 0 & . , - ' : ; ! ?

A B C D E F G H I J K L M N O P Q R S T

U V W X Y Z &

a b c d e f g g h i j k l m n o p q r s t u

v w x y z fi fl ff

\$ 1 2 3 4 5 6 7 8 9 0 % . , - ' : ; ! ?)

Roman Composition: 6, 8, 10, 12

DISPLAY: Roman & Italic: 14, 18, 24, 30, 36; Roman: 42, 48, 60, 72

Copperplate Gothic Bold #345

ABCDEFGHIJKLMNOPQRSTUVWXYZ

XYZ& \$1234567890 .,-'::!?

ABCDEFGHIJKLMNOPQRSTUVWXYZ&

\$1234567890 .,-'::!?

ABCDEFGHIJKLMNOPQRSTUVWXYZ&

\$1234567890 .,-'::!?

ABCDEFGHIJKLMNOPQRSTUVWXYZ&

\$1234567890 .,-'::!?

Composition: 6 and 12 point (1-4)

DISPLAY: Roman: 14, 18, 18H4, 24, 24H4

Copperplate Gothic Bold Italic #346

**ABCDEFGHIJKLMN OPQRSTUVWXYZ
XYZ& \$1234567890 .,-'':;!?**

**ABCDEFGHIJKLMN OPQRSTUVWXYZ&
\$1234567890 .,-'':;!?**

**ABCDEFGHIJKLMN OPQRSTUVWXYZ&
\$1234567890 .,-'':;!?**

**AECDEFGHIJKLMN OPQRSTUVWXYZ &
\$1234567890 .,-'':;!?**

Composition: 6 point (1-4)

Copperplate Gothic Heavy #168

Designed by Goudy in 1903, resulting in a deluge of designs,
e.g. ATF's Clarence Marder & Morris Benton.

**A B C D E F G H I J K L M N O P Q R S T U V
W X Y Z & Æ Œ
\$ 1 2 3 4 5 6 7 8 9 0 & .,-'':;!?**

DISPLAY: Roman: 14, 18, 18H4, 24, 24H4 (Comp is #342 below)

Copperplate Gothic Heavy #342

**ABCDEFGHIJKLMN OPQRSTUVWXYZ&
\$1234567890 .,-'':;!?**

**ABCDEFGHIJKLMN OPQRSTUVWXYZ&
\$1234567890 .,-'':;!?**

**ABCDEFGHIJKLMN OPQRSTUVWXYZ&
\$1234567890 .,-'':;!?**

**ABCDEF GHIJKLMN OPQRSTUVWXYZ &
\$1234567890 .,-'':;!?**

Comp: 6 and 12 point: (1-4) (Display is Copperplate Gothic Heavy #168)

Copperplate Gothic Heavy Condensed #169

A B C D E F G H I J K L M N O P Q R S T
U V W X Y Z &
\$ 1 2 3 4 5 6 7 8 9 0 . , - ' : ; ! ?

DISPLAY: Roman: 14, 18, 18H4, 24, 24H4 (Comp is #343 below)

Copperplate Gothic Heavy Condensed #343

ABCDEFGHIJKLMNOPQRSTUVWXYZ&
\$1234567890 .,-'':;!?

ABCDEFGHIJKLMNOPQRSTUVWXYZ&
\$1234567890 .,-'':;!?

ABCDEFGHIJKLMNOPQRSTUVWXYZ&
\$1234567890 .,-'':;!?

ABCDEFGHIJKLMNOPQRSTUVWXYZ&
\$1234567890 .,-'':;!?

Composition: 6 point (1-4) (Display is #169 above)

Copperplate Gothic Heavy Extended #166

A B C D E F G H I J K L M N O P Q R S T
U V W X Y Z &
\$ 1 2 3 4 5 6 7 8 9 0 . , - ' : ; ! ?

Roman Composition: 8, 10
DISPLAY: Roman: 8, 10, 14, 14B, 18, 18H4

Copperplate Gothic Light #187

A B C D E F G H I J K L M N O P Q R S T U V
W X Y Z &

\$ 1 2 3 4 5 6 7 8 9 0 . , - ' : ; ! ?

DISPLAY: Roman: 14, 18, 18H4, 24, 24H4 (Comp is #340, below)

Copperplate Gothic Light #340

ABCDEFGHIJKLMNOPQRSTUVWXYZ&

\$1234567890 .,-'':;!?

ABCDEFGHIJKLMNOPQRSTUVWXYZ&

\$1234567890 .,-'':;!?

ABCDEFGHIJKLMNOPQRSTUVWXYZ&

\$1234567890 .,-'':;!?

ABCDEFGHIJKLMNOPQRSTUVWXYZ&

\$1234567890 .,-'':;!?

Roman Composition: 6, 12 (Nos. 1-4) (Display is Copperplate Gothic Light #187)

Copperplate Gothic Light Condensed #197

THE AUTOMATIC CASTING MACHINE
RUNS AT THE MAXIMUM SPEED REGARDLESS OF WHETHER
THE MATTER BE PLAIN OR INTRICATE

\$1234567890

DISPLAY: Roman: 14,18,18H4, 24, 24H4

Copperplate Gothic Light Condensed #341

No. 1

ABCDEFGHIJKLMNOPQRSTUVWXYZ

\$1234567890

No. 2

ABCDEFGHIJKLMNOPQRSTUVWXYZ

\$1234567890

No. 3

ABCDEFGHIJKLMNOPQRSTUVWXYZ

\$1234567890

No. 4

ABCDEFGHIJKLMNOPQRSTUVWXYZ

\$1234567890

Composition: 6 point: (1-4)

Draftsman Gothic # 124

ABCDEFGHIJKLMNOPQRSTUVWXYZ

abcdefghijklmnopqrstuvwxyz 1234567890 .,:-'()- " "

DISPLAY: Italic: 14

Franklin Gothic #107

(Designed by Morris Fuller Benton at ATF 1903-1912)

ABCDEFGHIJKLMNOPQRSTUVWXYZÆ&

abcdefghijklmnopqrstuvwxyzæ& fiffiffiffi

\$1234567890 .,-“”;!?

Roman Composition: 4, 5, 6, 8, 10, 12

DISPLAY: Roman: 14, 18, 24, 30, 36, 42, 48, 60, 72

Franklin Gothic Condensed #707

A B C D E F G H I J K L M N O P Q R S T
U V W X Y Z &
a b c d e f g h i j k l m n o p q r s t u v w x y z
\$ 1 2 3 4 5 6 7 8 9 0 . , - ' : ; ! ?

Roman Composition: 12
DISPLAY: Roman: 14, 18, 24, 30, 36, 42, 48, 72

Franklin Gothic Extra Condensed #507

A B C D E F G H I J K L M N O P Q R S T U
V W X Y Z &
a b c d e f g h i j k l m n o p q r s t u
v w x y z
\$ 1 2 3 4 5 6 7 8 9 0 . , - ' : ; ! ?

DISPLAY: Roman: 14, 18, 24, 30, 36, 48-H4 figs only, 60, 72

Globe Gothic #240

Based on Taylor Gothic by ATF c. 1897, at the suggestion of the Boson *Globe's*
Charles H. Taylor:

A B C D E F G H I J K L M N O P Q R S
T U V W X Y Z &
a b c d e f g h i j k l m n o p q r s t u v
w x y z
\$ 1 2 3 4 5 6 7 8 9 0 . , - : ; ' ! ?

Roman Composition: 6, 10 DISPLAY: 14, 18, 24 (all caps only)

Globe Gothic Condensed #239

**A B C D E F G H I J K L M N O P Q R S T U V
W X Y Z &**

**a b c d e f g h i j k l m n o p q r s t u v w x y z
\$ 1 2 3 4 5 6 7 8 9 0 . , - : ; ' ! ?**

DISPLAY: 14 caps only

Globe Gothic Extra Condensed #230

**abcdefghijklmnopqrstuvwxy
ABCDEFGHIJKLMNOPQRSTUVWXYZ
\$1234567890**

Roman Composition: 12
DISPLAY: 14, 18, 24

Gothic Caps Condensed #48

**ABCDEFGHIJKLMNOPQRSTUVWXYZ&ÆŒ
\$1234567890 .,-“’:;!?**

Roman Composition: 6, 8, 10, 12

Gothic Condensed #49

**ABCDEFGHIJKLMNOPQRSTUVWXYZ&ÆŒ
abcdefghijklmnopqrstuvwxyæœ fiflffffiff
\$1234567890 .,-“’:;!?**

Roman Composition: 5, 6, 8, 10, 12

Gothic Condensed No. 124 — #110

ABCDEFGHIJKLMNOPQRSTUVWXYZabcdefghijklmnopqrstuvwxyz
\$1234567890?;:,.

DISPLAY: 6, 8, 10, 12

Gothic Condensed Title #43

A B C D E F G H I J K L M N
O P Q R S T U V W X Y Z &
\$ 1 2 3 4 5 6 7 8 9 0
. , - ' : ; ! ?

Display: 48, 60, 72

Gothic Number 3 — #249

abcdefghijklmnopqrstuvwxy
ABCDEFGHIJKLMNOPQRSTUVWXYZ
\$1234567890

Roman Composition: 8, 10, 12

Inclined Gothic #254

Marder & Luse had a version in 1893, later sold by ATF etc...

**THE MONOTYPE SYSTEM SUPPLIES
PRINTERS WITH THE MEANS FOR PRODUCING WORK OF
THE HIGHEST QUALITY
\$1234567890**

DISPLAY: 14, 14B, 18, 24, 30

Inland Gothic No. 6 — #149

Inland face for 1895, adopted by Lanston before it had sans serif faces.

A B C D E F G H I J K L M N O P Q R S T U V W X Y Z & Æ Æ

a b c d e f g h i j k l m n o p q r s t u v w x y z æ œ fi fl ffffiff

\$ 1 2 3 4 5 6 7 8 9 0 . , - ' : ; ! ?

Roman Composition: 5 1/2, 6, 8, 10, 12

Jefferson Gothic — see News Gothic Extra Condensed

Lining Gothic (Light) #106

A B C D E F G H I J K L M N O P Q R S T U V W X Y Z & Æ Æ

a b c d e f g h i j k l m n o p q r s t u v w x y z æ œ

\$ 1 2 3 4 5 6 7 8 9 0 . , - ' : ; ! ?

Roman Composition: 10, 12

Lining Gothic Mid No. 2 — #176

A B C D E F G H I J K L M N O

P Q R S T U V W X Y Z & Æ Æ

a b c d e f g h i j k l m n o p q r s t

u v w x y z æ œ fi fl ff ffi ffl

\$ 1 2 3 4 5 6 7 8 9 0 £ . , - ' : ; ! ?

Roman comp: 8, 10, 12; DISPLAY: Roman: 14, 18, 24

Lining Gothic Mid No. 2 — #276

A B C D E F G H I J K L M N O P Q R

S T U V W X Y Z &

a b c d e f g h i j k l m n o p q r s t u v w x y z

\$ 1 2 3 4 5 6 7 8 9 0 . , - ' : ; ! ?

DISPLAY: Roman: 14, 18, 24, 30, 36

Lining Gothic No. 545 — #66

ABCDEFGHIJKLMNOPQRSTUVWXYZ&ÆŒ

abcdefghijklmnopqrstuvwxyzæœ fiflffffl

\$1234567890 .,-'::!?

Roman: Composition 5, 6, 12

DISPLAY: Roman: 14, 18, 24, 30, 36

Lining Gothic No. 7 (Inland) — #165

ABCDEFGHIJKLMNOPQRSTUVWXYZ

\$1234567890

Roman Composition: 5, 6, 8

Lining Gothic No. 545 — #349

ABCDEFGHIJKLMNOPQRSTUVWXYZ&

\$1234567890 .,-'::!?

ABCDEFGHIJKLMNOPQRSTUVWXYZ&

\$1234567890 .,-'::!?

ABCDEFGHIJKLMNOPQRSTUVWXYZ&

\$1234567890 .,-'::!?

ABCDEFGHIJKLMNOPQRSTUVWXYZ&

Roman Composition: 6, Nos. 1-4

Lining Gothic No. 554 — #129

A B C D E F G H I J K L M N O

P Q R S T U V W X Y Z & Æ Œ

a b c d e f g h i j k l m n o p q r

s t u v w x y z æ œ fi fl ff ffi ffl

\$ 1 2 3 4 5 6 7 8 9 0 £ ., - ' : ; ! ?

DISPLAY: 14, 18, 24

Lining Gothic, Philadelphia #52

A MS&J face for the late 1800's, updated by Lanston in 1912.

A B C D E F G H I J K L M N O P Q R
S T U V W X Y Z & Æ Æ
a b c d e f g h i j k l m n o p q r s t u
v w x y z fi fl ff ffi ffl æ œ
\$ 1 2 3 4 5 6 7 8 9 0 £ . , - ' : ; ! ?

DISPLAY: Roman: 14, 18, 24, 30, 36

Modern Gothic Condensed (Tourist Gothic) #140

Sol Hess designed the Art Deco rounded characters in 1928, added to this version of the BB&S faces of 1897...

R A B C C D E E E F F G G H I J J K K L M M N N
O P Q R R S S T U V W W X X Y Y Z & Æ Æ £
a b c d e f g h i j k l m n o p q r s t u v w x y z æ œ
\$ 1 2 3 4 5 6 7 8 9 0 . , - ' : ; ! ?

Roman Composition: 6, 8, 10, 12

DISPLAY: Roman: 14, 18, 24, 30, 36, 36H4, 42, 48, 60, 72

Alts: H-9: 14, 18, 24, 30, 36, 48, 60, 72

A B C D E F G H I J K L M N O P Q R S
T U V W X Y Z &
a b c d e f g h i j k l m n o p q r s t u
v w x y z
\$ 1 2 3 4 5 6 7 8 9 0 . , - ' : ; ! ?

Italic Display: 14, 18, 24, 30, 42, 48, 60

News Gothic Condensed #204

ABCDEFGHIJKLMNOPQRSTUVWXYZ&Æ
abcdefghijklmnopqrstuvwxyzæø fiflffffiff
\$1234567890 .,-':;!?

Upright Composition: 6, 7, 8, 9, 10, 11, 12, 12 H3
DISPLAY: Roman: 14, 18, 24

News Gothic Bold Condensed #205

ABCDEFGHIJKLMNOPQRSTUVWXYZ Æ Æ &
abcdefghijklmnopqrstuvwxyz æø fiffllffiff
1234567890% \$.,-':;!?'-')/

Upright Composition: 6, 7, 8, 9, 10, 11, 12

News Gothic #206

By Morris F. Benton in 1908, to modernize 19th Century gothics at ATF.

ABCDEFGHIJKLMNOPQRSTUVWXYZ&
abcdefghijklmnopqrstuvwxyz
\$1234567890 .,-':;!?'()"/°¢%—=+

Upright Composition: 6, 7, 8, 9, 10, 11, 12
DISPLAY: Roman: 14, 18, 24, 30

publisher and bo abcdefghijklmnopqrstuvwxyz
ABCDEFGHIJKLMNOPQRSTUVWXYZ 12345

Sloped Composition: 8, 9, 10, 11

News Gothic Bold #93

ABCDEFGHIJKLMNOPQRSTUVWXYZ&
abcdefghijklmnopqrstuvwxyz
\$1234567890 .,-':;!?'()"/°¢%—=+

1/4 1/2 3/4 1/8 3/8 5/8 7/8 1/3 2/3 1/6 \$1234567890

Roman Composition: 5, 6, 7, 8, 9, 10, 11, 12
DISPLAY: Roman: 14, 18, 24

News Gothic Extra Condensed #227

(aka Jefferson Gothic)

A A B C D E F G H I J K K L M M N O P Q R R
S S T U V W W X Y Z &
\$ 1 2 3 4 5 6 7 8 9 0 . , - ' : ; ! ?

DISPLAY: Roman: 14, 18, 24, 30, 36, 48, 60, 72

Alternate Characters: 14, 18, 24, 30, 36

Outline Gothic Medium Condensed (Triangle)

(aka Tourist Outline Gothic)

A B C D E F G H I J K L M N O P Q R S T
U V W X Y Z & . ! ? : - \$ 1 2 3 4 5 6 8 0

DISPLAY: Roman: 18

Octic Gothic # 366

Lanston version of 19th Century faces.

A B C D E F G H I J K L
M N O P Q R S T U V
W X Y Z 0 1 2 3 4 5 6

Roman Composition: 10

DISPLAY: 14, 18, 30, 36

Spartan (English Monotype) #140

aka Plate Gothic

ABCDEFGHIJKLMNOPQRSTUVWXYZ&ÆŒ

1234567890

.,:;!?''-([†\$£\$*—

Roman Large Composition: 14, 18

(This face matches up with Lanston Copperplates 168/342)

Stationers Gothic Light #84

Designed by Sol Hess for Lanston in 1942, delayed by WWII until 1948.

ABCDEFGHIJKLMNOPQRSTUVWXYZ&

.,-''':;!?) \$1234567890

ABCDEFGHIJKLMNOPQRSTUVWXYZ&

.,-''':;!?) \$1234567890

ABCDEFGHIJKLMNOPQRSTUVWXYZ&

.,-''':;!?) \$1234567890

ABCDEFGHIJKLMNOPQRSTUVWXYZ&

.,-''':;!?) \$1234567890

Roman: Nos. 1-4 Composition, 6 pt; 18#2, 18#3

Stationers Gothic Bold #85

ABCDEFGHIJKLMNOPQRSTUVWXYZ&

.,-''':;!?) \$1234567890

ABCDEFGHIJKLMNOPQRSTUVWXYZ&

.,-''':;!?) \$1234567890

ABCDEFGHIJKLMNOPQRSTUVWXYZ&

.,-''':;!?) \$1234567890

ABCDEFGHIJKLMNOPQRSTUVWXYZ&

.,-''':;!?) \$1234567890

Roman Display: 18#2, 18#3

IV. Unique & Foreign Faces

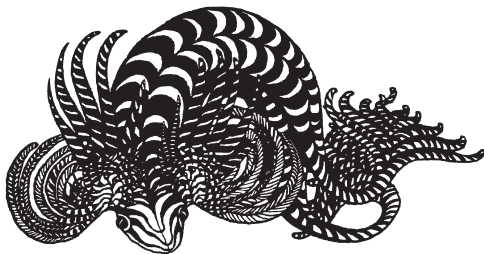

SWAMP PRESS

Aster (Russian) Linotype (cir. 10 ~ st)

This Italian book and newspaper font was designed by Francesco Simoncini in 1958

10 Aster (Linotype)

Новый проигрыватель аппарат «Зоркий» и авторучку. Все сразу? Ну знаете это даже глупо. Я с вами согласен, я своей дочери никогда не покупаю так много подарков, и я занимаюсь русским языком. Специалист он по истории Китая. Буду зарабатывать

10 Aster Italic (Linotype)

Но ведь ты всегда интересовался техникой подожди а мясокомбинат? У тебя та есть знакомый сам помощник директора какую ты хочешь получить профессию? Нет, я об этом больше не мечтаю. Чтобы стать инженером, нужно пять лет учиться. Все-таки

Special DISPLAY casting: 10 Roman and Italic

Braille

Matrices for both embossing Braille and printing Braille have been made at Swamp Press. This is beginner's Braille and the printing Braille cannot be used by visually impaired people but is useful for raising awareness of Braille among the sighted.

39 Characters, available in fonts or gold box samplers.

A reference character is cast on the shoulder of each piece of type and will not emboss or print, to help with setting.

⠠ ⠠ ⠠ ⠠ ⠠ ⠠ ⠠ ⠠ ⠠ ⠠ ⠠ ⠠ ⠠ ⠠
A B C D E F G H I J K L M N

⠠ ⠠ ⠠ ⠠ ⠠ ⠠ ⠠ ⠠ ⠠ ⠠ ⠠
O P Q R S T U V W X Y Z

⠠ ⠠ ⠠ ⠠ ⠠ ⠠ ⠠ ⠠ ⠠ ⠠ ⠠ ⠠ ⠠ ⠠ ⠠ ⠠ ⠠
ONE 2 3 4 5 6 7 8 9 ZERO &

⠠ ⠠ ⠠ ⠠ ⠠ ⠠
, , ! ? = : ;

Gaelic #24 (English Monotype)

abcdeęzhiłmnoprstu
ābċōēřżimōpřčŭ
abcdeęzhiłmnoprrtu
ābċōēřżimōpřčŭ

composition casting & fonts: 12 pt

Gaelic #85 (English Monotype)

abcdeęzhiłmnoprstu
ābċōēřżimōpřčŭ
abcdeęzhiłmnoprrtu
ābċōēřżimōpřčŭ

composition casting & fonts: 12 pt

German

Kasseler Fraktur + Halbfetter Kasseler Fraktur
#40 and #41 English Monotype

A B C D E F G H I J K L M N O P Q R S T U V W X Y Z Ű Ų Ŵ
abcdefghijklmnopqrstuvwxyzäöüchffffifllsijffiftß .,:;!?'()[]'s," —

Erhaltung des Wissens; und die in der ersten Zeit gedruckten Bücher konnten es sehr bald mit der Schönheit der feinsten Manuskripte jener Zeit aufnehmen, wie ihnen dies Die Erfindung des Buchdrucks mit beweglichen Lettern war eines der wichtigsten Ereignisse in der Geschichte

12D (13 pt) composition

Greek, #37S

Γ Δ Θ Λ Ε Π Σ Φ Ψ Ω

Combines with 14 characters of English Caslon #37 for the complete alphabet.

DISPLAY: 30 pt

Greek, Porson #155

(Designed by Richard Porson, cut by Richard Austin for Cambridge University in 1806. Monotype made this version in 1912.)

Α Β Γ Δ Ε Ζ Η Θ Ι Κ Λ Μ Ν Ξ Ο Π Ρ Σ Τ Υ Φ Χ Ψ Ω

α β γ δ ε ζ η θ ι κ λ μ ν ξ ο π ρ σ τ υ φ χ ψ ω ϑ Ϻ

Misc. Sorts of 6, 8, 10, 12; (limited accents available)

Hebrew

Frank Ruehl & Mirjam (Intertype #1804)

Frank-Rühl (or Ruehl) is the ubiquitous Hebrew text font style. There are many fonts that belong to this style, and all are based on an early 20th-century design by Raphael Frank. Some of the fonts are actually called Frank-Rühl (or Ruehl) and some are not.

10 Pt. Frank Ruehl with Mirjam. Font No. 1804

Lower case alphabet

12345 שטאָנדאַרדירונג אין שורות' דיגע שריפטזעצונג מאַשינעס ווי עס איז פאַר
12345 שטאָנדאַרדירונג אין שורות' דיגע שריפטזעצונג מאַשינעס ווי עס איז פאַר

Special DISPLAY casting (Intertype): 10

Hebrew (Intertype)

12345 רדיוירונג אין שורות'
די ערפאָלגרייבע שטאַנדאָ

SPECIAL DISPLAY casting: 20 (#1432)

Japanese

(Miscellaneous foundry style matrices, 119 mats in all)



Lorimer & Remson (Russian (Linotype 680))

8 Pt. Russian Lorimer with Remson Bold. Font 680

Интертип состоит из машины, составляющей
одно целое и принадлежностей, кот 12345

Интертип состоит из машины, составляющей
одно целое и принадлежностей, кот 12345

Display: 8 (Faces are cast separately)

Ruthenian #308 (Ukranian / Russian)

абвгдежзийїіклмнопрстуфхцщщюяє
АБВГДЕЖЗИЙІІКЛМНОПРСТУФХЦЩЩЮЯЄ
1234567890

Roman Composition: 8, 10, 12

This face is an adaptation of #8 Modern, and is Ukranian—
additional characters convert the font to Russian

Ruthenian #318 (Ukranian / Russian)

абвгдежзийїіклмнопрстуфхцщщюяє
АБВГДЕЖЗИЙІІКЛМНОПРСТУФХЦЩЩЮЯЄ
1234567890

Roman: 8, 10, 12

This face is an adaptation of #118 Century Bold, and is Ukranian—
additional characters convert the font to Russian

Cherokee Font Schemes

One-Eighth Font Scheme for Cherokee 36 pt

(Count, Character, Swamp designation: e.g.: 3 pieces, **R**, matrix no.1)

Pieces	Character	Matrix #	Pieces	Character	Matrix #	Pieces	Character	Matrix #	Pieces	Character	Matrix #	Pieces	Character
2	R	1	1	H	27	2	S	53	1	B	79	3	6
9	T	2	1	ʒ	28	1	ʔ	54	2	ʒ	80	3	7
2	ʒ	3	1	ʔ	29	11	J	55	1	ʒ	81	3	8
8	ʔ	4	4	ʔ	30	1	J	56	1	ʒ	82	4	9
2	i	5	1	G	31	3	V	57	2	B	83	7	0
10	S	6	2	ʔ	32	2	S	58	1	L	119	2	&
1	ʔ	7	4	h	33	2	ʔ	59	14	D	118	3	*
2	P	8	2	Z	34	1	ʒ	60	8	.		--	§
8	ʔ	9	1	ʔ	35	1	L	61	14	,		3	¶
3	A	10	3	ʔ	36	1	C	62	3	;		--	•
1	J	11	1	t	37	1	ʔ	63	3	:		2	—
2	E	12	2	T	38	1	ʔ	64	2	!		2	†
3	ʔ	13	1	ʔ	39	1	P	65	2	?		--	~
1	ʔ	14	1	ʔ	40	2	G	66	4	‘		3	/
5	ʔ	15	1	ʔ	41	1	V	67	4	’		3	\
1	F	16	1	ʔ	42	3	h	68	3	-			
1	F	17	1	ʔ	43	1	K	69	4	(
1	ʔ	18	1	U	44	2	J	70	4)			
3	W	19	15	ʔ	45	2	C	71	3	[
2	ʔ	20	1	ʔ	46	2	G	72	3]			
5	P	21	2	ʔ	47	1	ʔ	73	2	\$			
2	G	22	1	ʔ	48	2	ʔ	74	6	1			
1	M	23	1	ʔ	49	1	ʔ	75	4	2			
2	ʔ	24	2	R	50	1	ʔ	76	4	3			
1	ʔ	25	7	ʔ	51	1	ʔ	77	3	4			
1	ʔ	26	2	W	52	2	ʔ	78	3	5			

Other sized fonts of Cherokee are available. Typically I stock 1/4 and 1/8 fonts in all three point sizes, 14, 18, 24 and 36 point.

Cherokee Font Schemes

One-Eighth Font Scheme for Cherokee 24 pt

(Count, Character, Swamp designation: e.g.: 3 pieces, **R**, matrix no.1)

Pieces	Character	Matrix #	Pieces	Character	Matrix #	Pieces	Character	Matrix #	Pieces	Character	Matrix #	Pieces	Character
2	R	1	1	H	27	2	S	53	1	β	79	3	6
9	T	2	1	ᵐ	28	1	ᵐ	54	2	ᵐ	80	3	7
2	ᵐ	3	1	ᵐ	29	11	J	55	1	ᵐ	81	3	8
8	ᵐ	4	4	ᵐ	30	1	J	56	1	ᵐ	82	4	9
2	i	5	1	G	31	3	V	57	2	B	83	7	0
10	S	6	2	ᵐ	32	2	S	58	1	L	119	2	&
1	ᵐ	7	4	h	33	2	ᵐ	59	14	D	118	2	*
2	F	8	2	Z	34	1	ᵐ	60	8	.		--	§
8	ᵐ	9	1	ᵐ	35	1	ᵐ	61	14	,		2	ᵐ
3	A	10	3	ᵐ	36	1	C	62	3	;		--	•
1	J	11	1	t	37	1	ᵐ	63	3	:		2	—
2	E	12	2	T	38	1	ᵐ	64	2	!		2	†
3	ᵐ	13	1	ᵐ	39	1	P	65	2	?		--	~
1	P	14	1	ᵐ	40	2	G	66	4	'		2	/
5	ᵐ	15	1	ᵐ	41	1	V	67	4	'		2	\
1	F	16	1	ᵐ	42	3	h	68	3	-			
1	ᵐ	17	1	ᵐ	43	1	K	69	4	(
1	ᵐ	18	1	U	44	2	J	70	4)			
3	W	19	15	ᵐ	45	2	C	71	2	[
2	ᵐ	20	1	ᵐ	46	2	G	72	2]			
5	F	21	2	B	47	1	ᵐ	73	2	\$			
2	G	22	1	ᵐ	48	2	ᵐ	74	6	1			
1	M	23	1	ᵐ	49	1	ᵐ	75	4	2			
2	ᵐ	24	2	R	50	1	ᵐ	76	4	3		\$80.00	
1	ᵐ	25	7	ᵐ	51	1	ᵐ	77	3	4			
1	ᵐ	26	2	W	52	2	ᵐ	78	3	5			

11-2-17

Cherokee Font Schemes

Quarter Font Scheme for Cherokee 18 pt

(Count, Character, Swamp designation: e.g.: 3 pieces, **R**, matrix no.1)

Pieces	Character	Matrix #	Pieces	Character	Matrix #	Pieces	Character	Matrix #	Pieces	Character	Matrix #	Pieces	Character
3	R	1	2	H	27	3	S	53	2	B	79	4	6
15	T	2	2	ʒ	28	2	ᵀ	54	3	ᵀ	80	4	7
4	ᵀ	3	2	ʒ	29	18	J	55	2	ᵀ	81	4	8
13	ᵀ	4	7	ᵀ	30	2	J	56	2	ᵀ	82	8	9
3	i	5	2	G	31	5	V	57	3	B	83	12	0
17	S	6	4	ᵀ	32	4	S	58	2	L	119	4	&
2	ᵀ	7	7	h	33	3	ᵀ	59	23	D	118	4	*
4	F	8	2	Z	34	2	ᵀ	60	14	.	4	§	
13	ʒ	9	2	ᵀ	35	2	ᵀ	61	24	,	4	¶	
5	A	10	6	ᵀ	36	2	C	62	6	;	4	•	
2	J	11	2	t	37	2	ᵀ	63	6	:	4	—	
4	E	12	3	ᵀ	38	2	ᵀ	64	4	!	3	†	
5	ᵀ	13	2	ᵀ	39	2	P	65	4	?	4	~	
2	P	14	2	ᵀ	40	4	G	66	8	‘	6	/	
9	ᵀ	15	2	ᵀ	41	2	V	67	8	’	6	\	
2	F	16	2	ᵀ	42	6	h	68	6	-			
2	ᵀ	17	2	ᵀ	43	2	K	69	8	(
2	ᵀ	18	2	U	44	3	J	70	8)			
5	W	19	26	ᵀ	45	4	C	71	6	[
2	ᵀ	20	2	ᵀ	46	3	G	72	6]			
9	F	21	3	ᵀ	47	2	ᵀ	73	4	\$			
3	G	22	2	ᵀ	48	3	ᵀ	74	10	1			
2	M	23	2	ᵀ	49	2	ᵀ	75	6	2			
4	ᵀ	24	3	R	50	2	ᵀ	76	6	3			
2	ᵀ	25	12	ᵀ	51	2	ᵀ	77	4	4			
2	ᵀ	26	3	W	52	3	ᵀ	78	4	5			

Hebrew Font Scheme

Hebrew Unpointed Distribution (somewhat added to *)
(Jerusalem Type Foundry (24pt))

#	Character	count	character	count
1	Aleph	30	.	13
2	Beth	18	,	11
3	Gimel	8	:	5
4	Daleth	14	;	4
5	He	34	!	3
6	Vau	56	?	3
7	Zayin	7	(3
8	Cheth	15)	3
9	Teth	6	{	3
10	Yod	50	}	3
11	Kaph	16	'	3
23	final Kaph*	7	“	3
12	Lamedh	22	-	4
138	Lamedh alt*	14	\	4
13	Mem	24	0	5
24	final Mem	15	1	5
14	Nun	16	2	5
25	final Nun	7	3	5
15	Samech	8	4	5
16	Ayin	17	5	5
17	Pe	8	6	5
26	final Pe	5	7	5
18	Tzadde	8	8	5
27	final Tzadde	5	9	5
19	Koph	8		
20	Resh	23		
21	Sin	25		
22	Tau	20		

= Montype assigned a number to each character, for reference purposes.

Font Schemes

Half Strength Jobbing Font (36a 16A)

a b c d e f g h i j k l m n o p q r s t u v w
36 10 16 20 58 12 10 24 36 4 6 20 14 32 32 12 4 26 32 40 18 8 10

x y z 1 2 3 4 5 6 7 8 9 0 . , ; : - ' ! ? () AE
6 10 4 16 10 10 8 8 8 8 8 10 16 20 30 6 6 8 10 4 4 10 4

OE ae oe ff fi fl ffi ffl A B C D E F G H I J K
4 4 4 6 8 6 6 6 16 6 8 10 26 6 6 12 16 4 4

L M N O P Q R S T U V W X Y Z & — \$
10 8 14 14 6 4 14 16 20 8 4 6 4 6 4 6 4 8

Quarter Strength Font Scheme (18a 10A)

(Swash Font to accompany Half Strength Font uses these amounts)

a b c d e f g h i j k l m n o p q r s t u v w
18 6 8 10 28 6 6 12 16 4 4 10 6 14 14 8 4 12 14 18 8 4 6

x y z 1 2 3 4 5 6 7 8 9 0 . , ; : - ' ! ? () AE
4 6 4 10 6 6 4 4 4 4 4 8 12 14 24 6 6 6 8 4 4 8 4

OE ae oe ff fi fl ffi ffl A B C D E F G H I J K
4 4 4 6 6 4 4 2 10 4 6 6 16 4 4 8 10 4 4

L M N O P Q R S T U V W X Y Z & — \$
6 6 10 10 4 4 8 10 12 6 4 4 4 4 4 4 4 4

SMALL CAP SCHEME

A B C D E F G H I J K L M N O P Q R S T U
8 3 4 5 13 3 3 6 8 2 2 5 6 8 8 3 2 7 8 10 4

V W X Y Z &
2 3 2 3 2 2

Font Schemes

1/8 Strength Font Scheme (9a 5A)

a b c d e f g h i j k l m n o p q r s t
9 4 6 7 13 6 4 7 10 4 4 7 6 10 10 4 3 10 10 10

u v w x y z
6 4 4 3 4 3

A B C D E F G H I J K L M N O P Q R S T
5 2 4 3 6 3 3 3 5 2 2 4 3 5 5 3 1 5 5 5

U V W X Y Z
3 2 2 1 2 1

. , - ' ; : ? ! \$ 1 2 3 4 5
6 6 2 3 1 1 1 1 2 3 2 2 2 2

6 7 8 9 0

2 2 2 2 4

Spacing Fonts

	Ems	Ens	Thick	Mid	Thin	Hair
1/2 Strength	75	40	100	80	80	40
1/4 Strength	50	30	60	40	40	20
1/8 Strength	25	15	30	20	20	20

Generally: "Thick" = 1/3 em, "Mid" = 1/4 em, "Thin" = 1/5 em, Hair = 2 pts
 For larger sizes more set (width) sizes may be added.

We sell spaces and quads by the lb. as well as in fonts priced by the lb.

If a case has say 2 caps and 4 lower case, figure on 3 or 4 fonts.

One method to determine how much spacing is required would be to count up say the lower case "a"s, then divide by the appropriate font strength, to determine the approximate number of fonts required in your type case.

DIDOT: 15 pt English approximates 14 Didot, 30 pt English similar to 28 D.
 I can supply both sizes of spacing.

NOW making: 20D, 18D, 16D, 14D and will soon add 12D and
 other sizes, and can cast type with Didot body,
 918 height to paper

For your information, a 1/2 strength spacing font of:

	12 point weighs 0.9 lbs
	14 pt weighs in at 1.2 lbs
	16 pt weighs in at 1 lbs 5.8 oz
	18 pt weighs in at 2.08 lbs
a 1/4 Strength font of	24 pt comes to 2.4 lbs
1/4	30 pt at 4 lbs
1/4	36 at 5.3 lbs
1/4	48 at 9 lbs
1/8 Strength	60 pt 6 lbs 4.6 oz
1/8	72 pt at 8 lbs 11 oz

COPPERS & BRASSES we now stock paper "coppers" and "brasses"
 12-36 point. \$0.40 per card or 3 cards for \$1. (24 pieces per card)

Lanston Series Numbers

Numerical listing of Lanston faces. Note: italic fonts add a "1" to the roman designation. Thus Plymouth italic is 601.

Modern Condensed	1	Gothic, Light Condensed	50
News	3	Gothic, Alternate (No. 1)	51
Cosmopolitan	4	also "Modernized Gothic"	
Post Text	5	Lining Gothic, Philadelphia	52
Agate	6	Ionic (Gothic, Lining #525)	56
Modern	8	Times New Roman Bold	57
Newspaper Modern	9	Jenson Old Style	58
DeVenne	11	Contour No. 4	59
Cheltenham Bold Outline	12	Plymouth	60
Modern	13	Cochin	61
Modern Medium Cond	14	Ionic	62
Farmer's Old Style	15	Latin Antique	63
Ronaldson Old Style	16	Cheltenham Old Style	64
Typewriter Remington Ribbon	17 L	Craw Clarendon	65
Modern Medium Extended	19	Gothic, lining No. 545	66
Century Expanded	20	MacFarland	68
Binny Old Style	21	Schoffer	69
French Cadmus	22	Typewriter Remington	70 L
Law Italic	23	French Old Style No. 552	71
Cushing Oldstyle	25	Typewriter Reproducing	72 L
Antique, Modern	26	Contour No. 5	73
Antique, Old Style	27	Typewriter Mailing List	74 L
Title	28	Bradley	75
Bruce Old Style No. 20	31	Antique, Modern Condensed	76
Tallone Max Factor	32	Alternate Gothic No. 2	77
Aldine	33	Caslon Old Roman	78
Modern No. 4	34	Caslon Bold	79
Atlantic	35	Modern	80
Scotch Roman	36	Clarendon	81
Caslon Old Style, English	37	Stationers Gothic Medium	82
Goudy Old Style Light	38	Vertical Greek	83M
Winchell	39	Stationers Gothic Light	84
Contour No. 1	40	Stationers Gothic Bold	85
DeVenne Outline Italic	41	Cheltenham Bold	86
DeVenne Outline	42	Cheltenham Bold Condensed	88
Gothic Condensed Title	43	Clearface	89
Ben Franklin Outline	44	Manila	92
Pabst Old Style	45	News Gothic Bold	93
Gothic, Light	47	Latin Condensed	94
Gothic, Caps Condensed	48	Cloister Black	95
Gothic, Condensed	49	Cloister Black, German	95M

Lanston Series Numbers

Howland Open	96	Antique, Bold Condensed	145
Powell	97	Condensed No. 54	146
Bookman Old Style	98	Inland Gothic No. 6	149
German No. 2	99M	French Round Face	150
German Heintzemann	100M	Wilson Series	152
German Schwabacher	101	Antique	153
Washington Text	102	Greek Porson	155M
Washington Text German	102M	Ionic, Round (Inland)	156
Title No. 104, Condensed	103	Century Old Style	157
Runic Condensed	104	Masterman	158
Title, Half	105	Hess Bold	159
Lining Gothic, Light	106	Greek Title	160
Franklin Gothic	107	Hess Title	161
Compressed No. 30	108	Litho Roman Light	162
Gothic, Wide	109	Adtype	163
Gothic Condensed No. 124	110	Cheltenham Wide	164
DeVenne Cond	111	Lining Gothic No. 7	165
Lining Gothic	112	Copperplate Gothic Heavy Ext	166
Caslon Condensed	113	Copperplate Gothic Heavy	168
Gothic, Tiffany	114	Copperplate Gothic Heavy Cnd	169
Law Italic	115	Typewriter Smith Premier	170 L
Grasset	117	Typewriter New Royal	171 L
Century Bold	118	Suburban French	172
Winchell Condensed	119	Renner	173
Modified No. 20	120	Renner Underscore	174
Chamfer Condensed	121	Bodoni	175
Contour No. 6	123	Lining Gothic Mid No. 2	176
Gothic, Draftsman	124	Alternate Gothic Cond No. 3	177
Lanston (Melior)	125	German Light	178
Initials, Massey	126	German Bold	179
Initials, Ben Franklin	127	Lanston (Melior) Bold	180
Title	128	Modern Roman Cancelled	182
Lining Gothic Medium	129	Greek, Inscription	183
Inclined Gothic Bold	132	Condensed Title Gothic	185
aka Modern Gothic Italic		Cheltenham Medium	186
Cushing Monotone	134	Copperplate Gothic Light	187
Caslon Old Style, Inland	137	Engravers Old English Bold	188
Process	138	Rockwell Antique	189
Howland	139	Stymie Light	190
Tourist Gothic	140	Russian, Church	191
aka Modern Gothic Condensed		Rockwell Antique Shaded	193
Cheltenham Bold Extra Cond	141	Bodoni Bold Shaded	194
John Hancock	142	French Round Face Cancelled	195
Strathmore Old Style	143	Copperplate Gothic Light Cnd	197
Antique, Bold	144	German News Face	199M

Lanston Series Numbers

GermanNews Face Bold	200M	Ionic, Wide No. 56	256
Comstock	202	Jenson Condensed	258
Comstock Condensed	203	Typewriter Oliver Printype	259 L
News Gothic Condensed	204	Cochin Open	262
Ticketograph Extra Condensed	205	Skeleton Gothic	263
aka News Gothic Bold Condensed		Cheltenham Old Style Cond	264
News Gothic	206	Copperplate Gothic Heavy Ext	266
Ticketograph	207	Kennerley Old Style	268
Ticketograph Condensed	208	Kennerley Bold	269
German Teutonic Title	209	Typewriter Underwood	270 L
Devinne Extra Cond No. 2	210	Typewriter Burroughs 02 Elite	271 L
Devinne (for 5.5 pt. body)	211	Typewriter Royal	272 L
Gothic, Western Union	212	Forum	274
Modern Medium Condensed	214	Bodoni Bold	275
Modern No. 3 Extra Cond	216	Lining Mid Gothic No. 2	276
Swing Bold	217	Typewriter IBM Elite	277 L
Cheltenham Bold Shaded	218	Goudy Lanston	279
Salem	220	Classic Hebrew	280
Overgrown No. 80	221	Ancient Hebrew	281
Gothic Condensed No. 3	222	Cooper Black	282
Engravers Roman	223	Cheltenham Inline Extended	285
Victoria Italic	224	Cheltenham Inline	286
Artscript	225	CHeltenham Bold Extended	287
Jefferson Gothic	227	Cheltenham Inline Extra Cond	288
aka News Gothic Extra Condensed		Clearface Italic	289
Lining Central Antique No.2	229	Stymie Medium	290
Globe Gothic Extra Cond	230	Goudy Open	291
Della Robbia	231	True Doric	292
Antique No. 6	233	Goudy Modern	293
Glamour Light	235	Goudy Bold	294
Glamour Medium	236	Cloister Bold	295
Glamour Bold	237	Initials, Goudy	296
Light Face Condensed No.7	238	Modernistic	297
Globe Gothic Condensed	239	Bookman Old Style Cond	298
Globe Gothic	240	Californian	300
Slimline	241	Goudy Bible	301
Hess Old Style	242	Brush	302
Italian Old Style	243	Long Primer Bold Latin	303
John Hancock Condensed	245	Long Primer Ionic	304
Title Shaded Litho	246	Fournier Le Jeune	305
Lining Latin Condensed	247	Broadway	306
Garamont	248	Broadway Engraved	307
Gothic No. 3	249	Ruthenian (based on Modern No.8)	308A
Cochin Bold Tooled	253	Hadriano	309
Title No. 55	255	Lombardic Caps	310

Lanston Series Numbers

Ruthenian (based on DeVenne No. 11)	311	Caps in Circle	365
Gallia	313	Gothic, Octic	366
Deepdene	315	Kennerley Open Caps	368
Deepdene Medium	316	Remington Underscored	370 L
Deepdene Bold	317	Reproducing Underscore	372 L
Russian No. 118	318	Flash	373
Binny Old Style Modified	321	Bodoni	375
aka Tallone Italic		Bold Antique	376
Broad-Stroke Cursive	322	Spire	377
Engravers Bold	323	Caslon Shadow Title	379
Goudy Cursive	324	Goudy Heavyface	380
Hess Monoblock	325	Goudy Heavyface Condens	382
Greco Bold	326	Goudy Handtooled	383
Goudy Text	327	Goudy Sans Serif Light	384
Bold Face No. 2	328	Goudy Sans Serif Bold	386
Sans Serif Light	329	Wedding Text	388
Sans Serif Bold	330	Stymie Extra Bold	390
Sans Serif Medium	331	Goudy Heavyface Open	391
Sans Serif Extra Bold	332	Goudy Thirty	392
Sans Serif Extra Bold Cond	333	Goudy Old Style	394
Artcraft	334	Cloister Old Style	395
Caslon Old Style	337	Bookman, New	398
Caps in Square	339	Granjon	400
Copperplate Gothic Light	340	Janson	401
Copperplate Gothic Light Con	341	Bell	402
Copperplate Gothic Heavy	342	Fournier	403
Copperplate Gothic Heavy Con	343	Onyx	404
Copperplate Gothic Heavy Ext	344	Bembo	405
Copperplate Gothic Bold	345	Streamline block	407
Copperplate Gothic Bold Italic	346	Hadrino Stone Cut	409
Engravers Roman	347	Goudy Village (No. 2)	410
Engravers Bold	348	Modern Condensed Italic	411
Lining Gothic No. 545	349	Valiant	412
Lining Gothic No. 7 Modified	350	Spediotype Light	417
Caps in Circle	351	Century Bold Condensed	418
Lightline Title Gothic	352	Century Schoolbook	420
Baskerville	353	Stylescript	425
Sans Serif Medium Cond	354	Goudy Text Shaded	427
Sans Serif Light Condensed	357	Sans Serif Lined	430
Pendrawn	358	Parson's Bold	431
Woman's Home Companion	359	Lt Hobo/Goudy Franciscan	432
Post Condensed	360	Caslon Old Style	437
Scotch Open Shaded Italic	361	Italian Old Style Wide	443
Times New Roman	362	Initials, Monotype	448
Hess Neobold	363	Lightline Gothic	452

Lanston Series Numbers

Baskerville Bold	453	Twentieth Century Light	606
Post Roman Heading Letter	458	20 th Century Extrabold Cond	607
Cochin, Nicolas	461	20 th Cent. Medium Condensed	608
Bulmer	462	Twentieth Century Ultra Bold	609
Gothic, Lining No. 545	466	20 th Century Ultra Bold Cond	610
Underwood Underscored	470 L	Twentieth Century Bold Cond	612
Remington Noiseless Elite	471 L	20 th Century Semi-Medium	613
Typewriter Royal Underscored	472 L	20 th Cen. Ultra Bold Extended	614
Flash Bold	473	Cochin Bold	616
Bradley, German	475	Spediotype Light	617
IBM Elite underscored	477 L	Century Text (?)	618
Westinghouse Gothic	479	Century Schoolbook Bold	620
Gothic (Helvetica Light)	481	Collier Heading	630
Cooper	482	Caslon, American	637
Westinghouse Gothic Light	489	Garamond, American	648
Stymie Extrabold Condensed	490	Craw Clarendon Book	650
Clositer Black, German	495	Clarendon (Bold) Extended	665
Gothic (Helvetica)	496	Redesigned Underwood	670 L
Granjon Bold	500	New Royal Underscored	671 L
Ward Extended	503	Ultra Bodoni	675
Montgomery Ward Light	505	Stymie Light Condensed	690
aka Ward(s) of Memphis)		Poster	700
Franklin Gothic Extra Cond	507	Remington Goudy Italic	701 L
Gothic (Helvetica Medium)	508	Franklin Gothic Condensed	707
Gothic, Condensed	515	Bodoni Bold Condensed	775
Spediotype Bold	517	Stymie Bold	790
Century Bold Extended	518	Bodoni Book	875
Century Mono-Photo (?)	520	Squareface	890
New Caslon	537	Piece Accents Roman	901
Gothic Condensed, New	543	Piece Accents, Bold	902
Garamond Bold	548	Piece Accents, Gothic	903
Caps in circle	551	Piece Accents, Open	904
Caps in Circle	565	Title, Half	905
Gothic, Octic No. 2	566	Recut Bodoni Bold	975
Remington Noiseless Elite		Runic Condensed Title	1041
Underscored	571 L	Devinne Italic	1111
Typewriter Reproducing Bold		Gothic, Inclined	2541
Broadface	572 L	Californian Italic (?)	3001
Bodoni Bold Panelled	575	Copperplate Gothic Bold Ital	3461
Cooper Tooled	582	Washington Text, German	4102
Stymie Medium Condensed	590	Script Caps	4491
Hess New Bookbold	600		
Twentieth Century Extrabold	603		
Twentieth Century Bold	604		
Twentieth Century Medium	605		

(The Monotype Corporation Ltd., England)

INDEX OF 'MONOTYPE' FACES

- | | | |
|-----------------------------------|--------------------------------------|---------------------------------|
| 1 Modern | 102 Alte Schwabacher | 201 Garamond Bold |
| 2 Old Style | 103 Gloucester Bold | 203 Van Dijck |
| 3 Antique Old Style | 105 Typewriter | 205 Unger Fraktur |
| 5 Albion | 106 Greek: Porson | 206 Pastonchi |
| 7 Modern Extended | 107 Egyptian | 207 Antique |
| 9 Latin Antique | 108 Italian Old Style | 209 Caslon Titling |
| 10 Ronaldson | 110 Plantin | 210 Musical Signs |
| 12 Clarendon | 113 Plantin Light | 211 Century |
| 13 Modern Condensed | 116 Breitkopf Fraktur | 213 Bernard Condensed |
| 14 Modern Condensed | 117 Gaelic: Sans-Serif | 214 Goudy Extra Bold |
| 15 Grotesque Bold Condensed | 118 Mainzer Fraktur | 215 Grotesque |
| 16 Modern Wide | 119 Blado Italic | 216 Grotesque Bold |
| 18 Modern Wide | 120 Bodoni Ultra Bold | 217 Hebrew: Peninim Pointed |
| 19 Elzevir | 121 Gaelic: Colm Cille | 218 Hebrew: Sonzino |
| 24 Gaelic | 122 Old Style (Prumyslava) | 219 Hebrew: Ashurith |
| 25 Modern Wide | 126 Grotesque Light | 220 Hebrew: Peninim |
| 26 Modern Wide | 127 Typewriter | 221 Hebrew: Levënim |
| 27 Neo Didot | 128 Caslon | 222 Hebrew |
| 28 Wittenberger Fraktur | 129 Egyptian Bold | 225 Colonna |
| 29 Wittenberger Fraktur Halbfette | 132 Mainzer Fraktur Halbfette | 227 Century Schoolbook |
| 30 Modern Wide | 135 Bodoni | 228 Hebrew: Rabbinic |
| 31 Armin Fraktur | 137 Scotch Roman | 230 Poliphilus Titling |
| 32 Armin Fraktur Fette | 139 Spartan Light | 231 Gill Sans Titling |
| 33 Grotesque Condensed | 140 Spartan | 233 Gill Sans Cameo |
| 35 Neue Schwabacher | 141 Spartan Bold | 235 Typewriter |
| 36 Neue Schwabacher Halbfette | 142 Spartan Light Condensed | 236 Plantin Bold Condensed |
| 39 Modern Condensed | 143 Spartan Condensed | 239 Perpetua |
| 40 Kasseler Fraktur | 144 Spartan Italic | 243 Gloucester Bold Extended |
| 41 Kasseler Fraktur Halbfette | 145 Spartan Wide | 246 Othello |
| 42 Albion | 146 Engravers' Titling | 249 Goudy Modern |
| 44 French Round Face | 147 Engravers' Bold Titling | 250 Modern Condensed |
| 46 Scotch Roman | 149 Italian Old Style Bold | 251 Egyptian Condensed |
| 51 Grotesque | 150 Grotesque Bold Expanded | 252 Centaur |
| 53 Old Style Bold | 151 Old Style | 255 Lutetia |
| 54 Modern Bold Italic | 154 Chiswell Old Face | 256 Dürer Fraktur |
| 56 Kölner Fraktur | 155 Devanagari | 258 Perpetua Titling |
| 58 Kölner Fraktur Fette | 156 Garamond | 259 Greek: Antigone |
| 60 Latin Antique | 157 Clearface Bold | 260 Bodoni Bold |
| 63 Albion | 159 Old Style Bold | 261 Horley Old Style Bold |
| 64 Moderne Fraktur | 160 Gloucester Bold Italic | 262 Gill Sans |
| 65 Neo Didot | 161 Antique Old Style | 263 Modern Cancellation Fount |
| 66 Moderne Fraktur Fette | 165 Cochin | 268 Goudy Catalogue |
| 68 French Old Style | 166 Grotesque Bold Condensed Titling | 269 Goudy Bold |
| 69 French Old Style Bold | 169 Baskerville | 270 Bembo |
| 70 Albion | 170 Poliphilus | 274 Grotesque Light Condensed |
| 71 Didot | 173 Egyptian | 275 Gill Sans Bold |
| 72 Egyptian Extended | 174 Garamond Italic | 277 Unger Fraktur Halbfette |
| 73 Grotesque Bold | 175 Rockwell Shadow | 278 Braggadocio |
| 74 Albion Extended | 176 Old Style Bold Outline | 280 Tamil |
| 78 Latin Antique | 178 Barbou | 282 Egyptian Bold Condensed |
| 81 Grotesque Bold Condensed | 179 Modern Titling | 285 Fournier Shortened Capitals |
| 82 Typewriter | 180 Victoria Bold Condensed Titling | 290 Gill Sans Shadow Line |
| 83 Würzberger Fraktur | 181 Victoria Condensed Titling | 291 Goudy Old Style |
| 85 Gaelic Display | 182 Victoria Titling | 292 Goudy Text |
| 86 Moderne Schwabacher | 185 Fournier | 293 Lombardic Capitals |
| 90 Greek: Upright | 189 Modern | 294 Bembo Condensed Italic |
| 91 Greek: Inclined | 190 Imprint Shadow | 295 Centaur Titling |
| 92 Greek: Bold Upright | 192 Greek: New Hellenic | 299 Gill Sans Cameo Ruled |
| 93 Moderne Schwabacher Halbfette | 194 Plantin Bold | 301 Typewriter |
| 98 Alte 'Monotype' Fraktur | 195 Bodoni Bold | 304 Gill Sans Shadow Titling |
| 99 Gloucester Old Style | 198 Gloucester Bold Condensed | 305 Kino |
| 100 Typewriter | 199 Horley Old Style | 306 Crossword Puzzle Solution |
| 101 Imprint | 200 Perpetua Bold Titling | 310 Imprint Bold |

INDEX OF 'MONOTYPE' FACES Numerical

312 Baskerville Bold	420 Runic Condensed	548 Lectern Missal
313 Baskerville Semi-bold	421 Times New Roman Semi-bold	549 Arabic Naskh
314 Fridericus Antiqua	424 Rockwell Extra Bold	553 Greek: Old Style Bold Inclined
317 Gill Sans Bold Titling	427 Times New Roman Wide	554 Festival Titling
318 Grottesque Condensed	428 Bembo Bold	555 Angelus
320 Emerson	429 Palace Script	556 Spectrum
321 Gill Sans Extra Bold	431 Floriated Capitals	557 Sinhalese
322 Script Bold	436 Dorchester Script	558 Burmese Light
323 Falstaff	437 Fontana Bible Face	559 Arabic Solloss
324 Albertus Titling	438 Plantin Titling	562 Ionic Two-line
325 Tonic-Sol-Fa	439 Goudy Titling	564 Syriac 'Estrangelo'
327 Times New Roman	441 Goudy Bold	565 Greek: Times Upright
328 Times Bold Titling	442 Gill Sans Ultra Bold	566 Greek: Times Inclined
329 Times Titling	446 Breilkopf Fraktur Fette	567 Greek: Times Bold Upright
332 Times Bold Titling	450 Laudian Old Style	568 Placard Condensed
333 Times Newspaper Smalls	453 Ehrhardt	569 Times Four-line Mathematics
334 Times Bold	455 Temple Script	570 Modern Bold
335 Times Newspaper Smalls	456 Old English Text	571 Greek: Gill Sans Inclined
338 Gill Sans Shadow	458 Romulus	572 Greek: Gill Sans Upright
339 Times Extended Titling	460 Gujerathi	573 Ehrhardt Semi-bold
340 Tamil Bold	461 Perpetua Bold	574 Ashley Script
341 Bell	463 Rundgotisch	577 Thai
342 Ionic	468 Gill Sans Bold Extra Condensed	578 Burmese Bold
343 Gill Sans Bold Condensed	469 Bulmer	580 Tamil Medium
345 Times Bold	470 Bengali	582 Rockwell Light Condensed (Film Sub-titles)
346 Devanagari Bold	472 Greek: Inclined	583 Swing Bold
349 Gill Sans	475 Script Light	584 Mercurius Bold Script
350 Gill Sans Bold	477 Century Schoolbook Bold	585 Greek: Gill Sans Condensed
351 Monoline Script	478 Joanna	586 Fabritius
352 Centaur	480 Perpetua Light Titling	587 Georgian
353 Gill Sans Poster	481 Albertus	588 Kannada
355 Times Hever Titling	483 Uhlen Rundgotisch	589 Arabic Naskh Accented
357 Bodoni	485 Gill Sans Condensed	590 Malayalam
359 Rockwell Bold Condensed	486 Greek: Sans-Serif	591 Onyx
360 Times Bold	488 Hebrew: Mayer Pointed	592 Dante
362 Gill Sans Light	489 Hebrew: Peninim	593 Klang
364 Goudy Catalogue	492 Hebrew: Mayer	595 Headline Bold
366 Inflex Bold	493 Grosvenor Script	597 Old Bulgarian
367 Breilkopf Fraktur	496 Matura	598 Glagolitic
370 Bembo Titling	504 Bodoni	599 Amharic
371 Rockwell	505 Placard Light Extra Condensed	600 Castellar
373 Gill Sans Bold Condensed Titling	506 Placard Bold Condensed	601 Gurmukhi Bold
374 Walbaum	507 Urdu	602 Typewriter IBM "Executive"
375 Walbaum Medium	508 Pegasus	603 Octavian
382 Musical Signs	509 Bembo Semi-bold	604 Gurmukhi
383 Grottesque Condensed	511 Condensa	605 Greek: Placard Light Extra Condensed
388 Grock	515 Placard Bold Condensed	608 Thai Light
390 Rockwell Light	518 Gujerathi Bold	609 Louvain Coptic
391 Rockwell Bold	520 Romulus Bold	611 Thai Bold
393 Missal	522 Placard Condensed Titling	612 Dante Titling
394 Poltawski	523 Grottesque Condensed Titling	613 Pepita
395 Gloucester Bold Extra Condensed	524 Grottesque Bold Titling	614 Forte
396 Gloucester Extra Condensed	525 Gill Sans Bold Condensed Titling	617 New Clarendon
397 Menhart	526 Gill Sans Extra Bold Titling	618 New Clarendon Bold
398 Poltawski Bold	527 Grottesque Bold Condensed Titling	619 Bell Gothic
399 Felix Titling	528 Matura Scriptorial Capitals	620 Bell Gothic Bold
403 Fontana	529 Bodoni Bold Condensed	621 Thai Medium
406 Gill Sans Shadow	534 Albertus Light	624 Amharic
408 Gill Sans Shadow	536 Figaro	625 Greek: Gill Sans Bold Upright
410 Imprint Bold	538 Albertus Bold Titling	626 Telugu Medium
413 Breilkopf Fraktur Halbfette	539 Georgian Light	627 Times New Roman Book
414 Rockwell Condensed	540 Georgian Bold	628 Thai Light Italic
419 Latin Condensed	544 Old Style Bold	

(The Monotype Corporation Ltd., England)

INDEX OF 'MONOTYPE' FACES

629 Traveller
632 Fleet Titling
638 Armenian
643 Berling
644 Berling Semi-bold
649 Arabic Naskh Bold
650 Century Schoolbook
651 Century Schoolbook Bold
657 Sinhalese Bold
660 Malayalam
662 Gill Sans Light
663 Plantin Semi-bold
667 Greek: Times Bold Inclined
668 Greek: Placard Condensed Upright
669 Sabon
672 Greek: Gill Sans Light Upright
673 Sabon Semi-bold
674 Walbaum
680 Grottesque Bold
682 Dante Semi-bold
683 Greek: Grottesque Condensed Upright
684 Univers Extra Light Extra Condensed
685 Univers Light
686 Univers Light Condensed
687 Univers Light Extra Condensed
688 Univers Medium Expanded
689 Univers Medium
690 Univers Medium Condensed
691 Univers Medium Extra Condensed
692 Univers Bold Expanded
693 Univers Bold
694 Univers Bold Condensed
695 Univers Extra Bold Expanded
696 Univers Extra Bold
697 Univers Ultra Bold Expanded
698 Sinhalese Italic
699 Sinhalese Bold Italic
700 Bengali
701 Bengali Bold
704 Gujerathi
706 Oriya
707 Urdu Bold
708 Tamil Medium
718 Greek: Grottesque Condensed Upright
721 Farsi
726 Telugu Bold
727 Times New Roman (Light Capitals)
739 Greek: Spartan Light Upright
740 Greek: Spartan Upright
741 Greek: Spartan Bold Upright
755 Devanagari Italic
760 Bodoni Bold Titling
773 Plantin Light
788 Kannada Bold
827 Times New Roman (French)

(The Monotype Corporation Ltd., England)

Type Anatomy

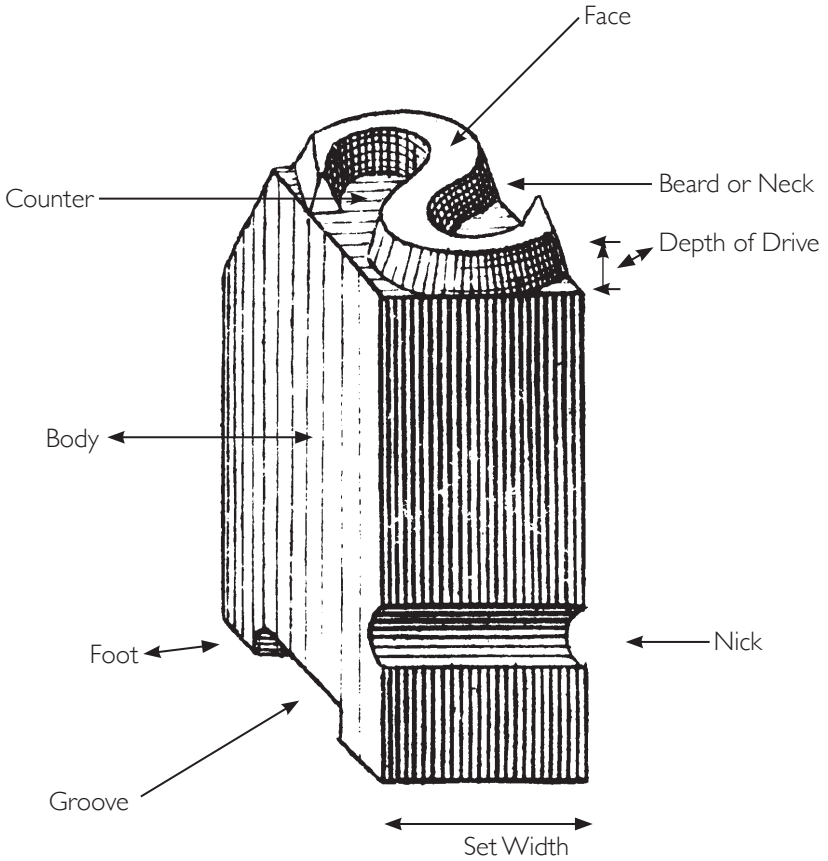

MOVABLE TYPE ANATOMY

Swamp Serpent Tooth Bodkin

Bodkin aka Makeready Punch \$25

Hardened steel point can be removed & stored in the handle & has a flat so the press platen will not be dented.

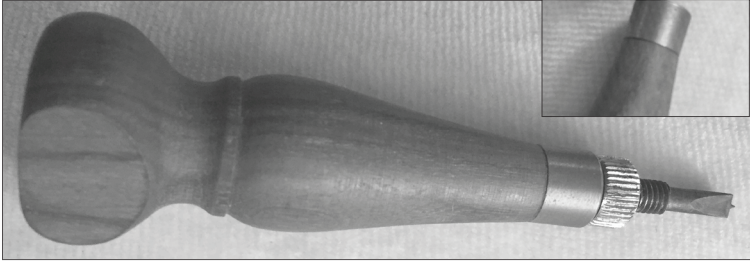

This handy tool is used to stab through a make-ready sheet over the tympan (which is then printed) to allow alignment of the sheet plus make-ready under the packing. The hardened tip is short and has a flat, so it will not hit the platen itself. Wild Carrot Letterpress was given this tool many years ago and we had it copied by a machinist, Lou Hebert. Storing the pointed tip inside the handle means it can be pocketed without one getting stabbed by the pointed end. We have never been able to find another example of this tool, and have no idea who made the original or when. All we know is it probably came from England.

Galley Magnets

Manufactured at Swamp Press for Letterpress Things.
Contact John Barrett to order: Letterpressthings@gmail.com

Here's a neat trick: if the magnet is in a tight spot and can't be easily extracted, put a second magnet on top of it to cancel the magnetism, and it lifts off easily. If the magnetism isn't cancelled, rotate the top magnet 180 degrees.

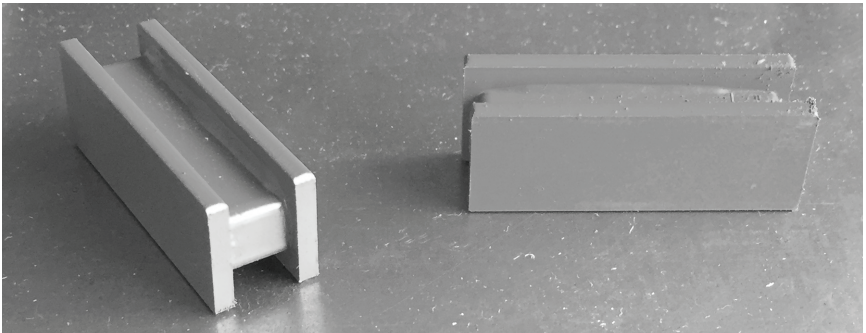

Benton Matrix Engraving

Matrices can be made from your digital files or scannable art.

Logos, ornaments, entire fonts. Faces done recently:
Pilot Black Italic (For the Fine Press Book Association),
Cherokee (in four sizes) (For Speakeasy Press).
Also ornaments, *Pinwheel* by Russell Maret.

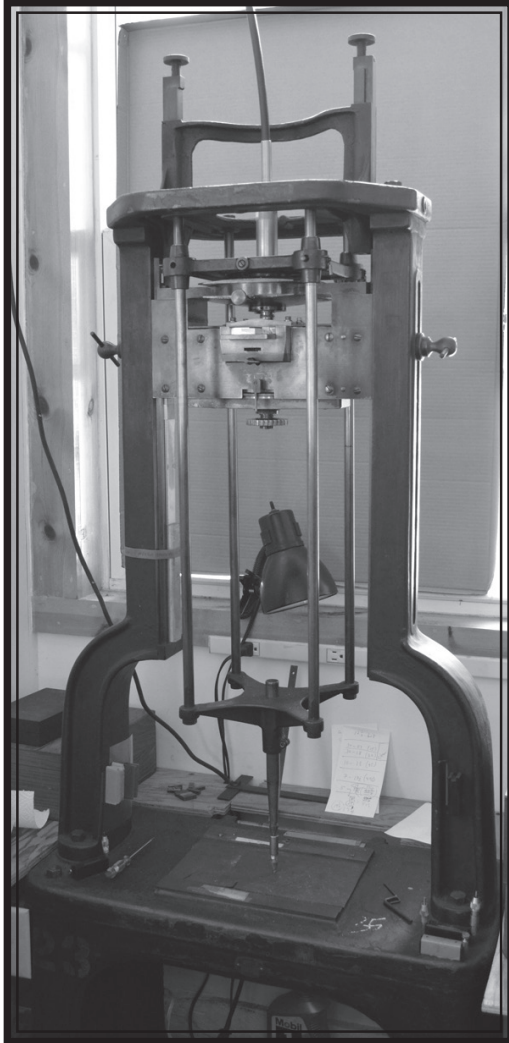

ATF Benton number 63

Specimen Books

ENGLISH MONOTYPE SPECIMEN BOOK OF RULES BORDERS FIGURES ETC (c. 1970)

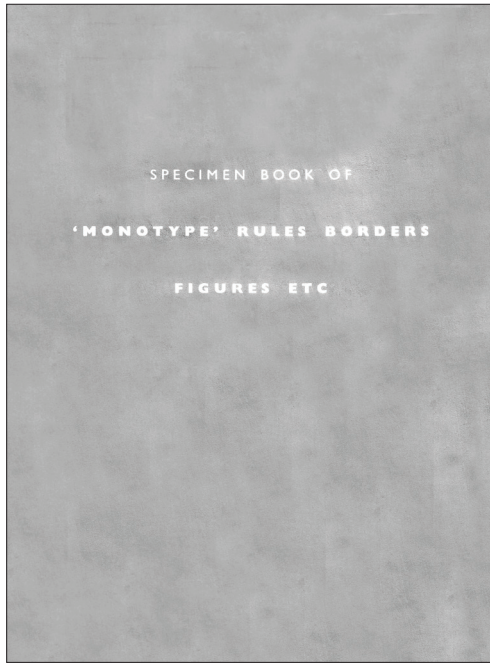

Reproduction of specimens from English Monotype circa 1970; probably the last collection of specimens issued. With permission of Monotype Imaging, the set of specimens were scanned and bound. Includes ornamental material not available in earlier Monotype specimen books.

While a reproduction can never replace the originals, this is a handy copy suitable for every day use in the shop or design studio which leaves your precious originals pristine, if you are lucky enough to have them.

Since the original sets varied due to assembly at different times, and the many revisions Monotype made, this volume more complete than any you are likely to find, anywhere. Many thanks to Pat Reagh for allowing me to scan his copy. \$45 postpaid.

Specimen Books

A SWAMP PRESS BOOK YOU MUST HAVE:

Ornadementia

- 276 large format pages (8.5x11 inches) packed with thousands of ornament specimens, perfect bound, versus a few hundred pages in the free PDF download.
- Call me old-fashioned, but I myself prefer leafing through a bound book made of actual paper versus scrolling through massive digital files. And no battery or electric outlet necessary!
 - Not only are there more ornaments shown, they are shown in all their sizes and arranged so that one can see the ornament's visual potential & glory.
- Ornaments that I have no matrices for are displayed so that you may nudge me into acquiring the means to cast your favorite dingbat for you.
 - A great gift for any typophile.
 - A bargain at \$45.00 postpaid to anywhere in the US of A.

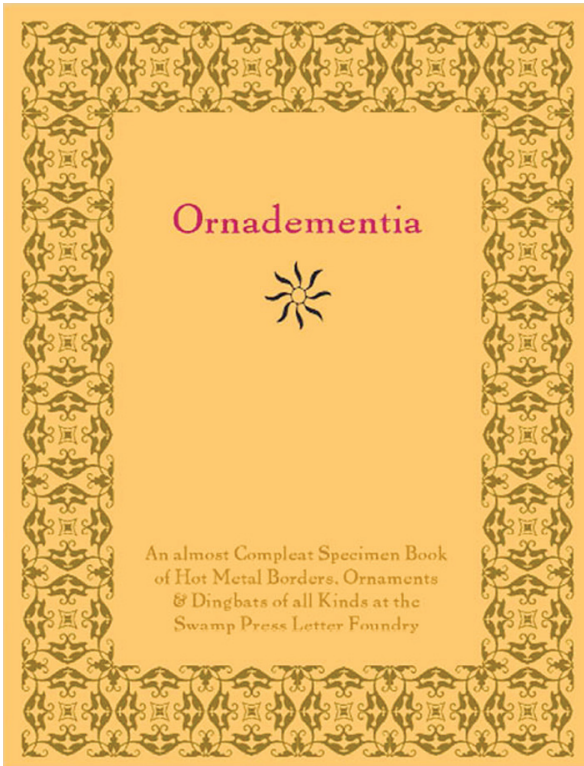

Specimen Books

ENGLISH MONOTYPE SPECIMEN BOOK

C. 1970

2 VOLUMES COIL BOUND

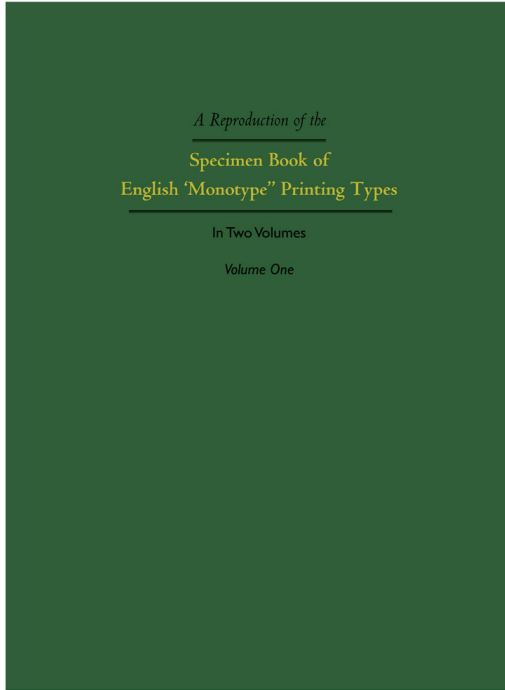

Under development. Reproduction of what most of us know as the two volume green ring binder set. With permission of Monotype Imaging, the complete set of specimens were scanned and bound. While a reproduction can never replace the original, this is a handy copy suitable for every day use in the shop or design studio which leaves your precious original pristine.

Since the original sets varied due to assembly at different times, this volume contains all the green binder type specimens from the 1970's era. Price \$105 postpaid.

Specimen Books

ENGLISH MONOTYPE SPECIMEN BOOK
THE EARLY DAYS
2 VOLUMES COIL BOUND

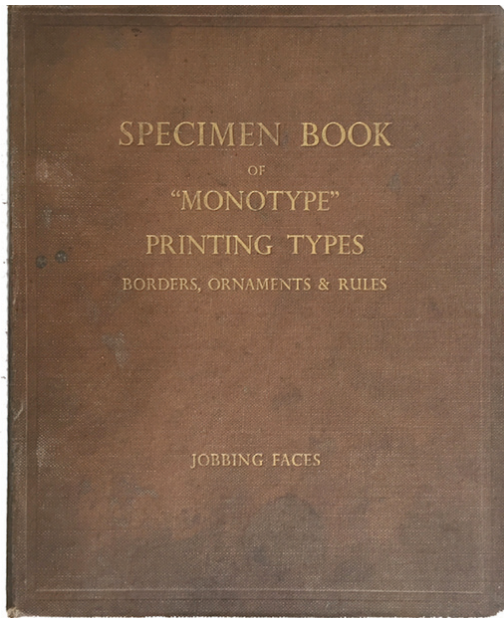

Under development. Reproduction of specimens from the beginnings of English Monotype up to 1970. Scans of many rare and discontinued faces With permission of Monotype Imaging, the complete set of specimens were scanned. Includes obscure faces such as Frakturs which were never included in the original specimen books and were available by special request only. While a reproduction can never replace the originals, this is a handy copy suitable for every day use in the shop or design studio which leaves your precious originals pristine, if you are lucky enough to have them.

Since the original sets varied due to assembly at different times, and the many revisions Monotype made, this volume contains a gathering representing all the pre-1970's era originals. Price TBD.

“GOLD BOX” Unique Ornaments &etc.

Friedlander Initials, Florentine Skulls, Vance Gerry, Braille, Twist, and Kliluk

(Detailed descriptions in previous pages)

Friedlander Initials
BY
Elizabeth Friedlander

A B C D E F G H I
J K L M N O P Q R S
T U V W X Y Z L

26 characters plus an alternate L
48 pt font cast on 42 except the J \$32

Vance Gerry

ENGRAVED FLOWERS

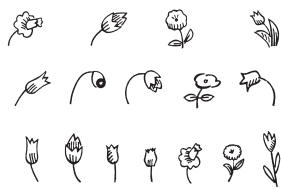

5 each of 16 flowers 18 pt \$25

Kliluk

A sampler of 18 pt Asemic Type
by *Barbara Henry*



\$35 • Ten pieces each of characters 1-7
and of mirror images of 1-3, 5&6

Florentine Series no. 1
Skulls & Crossbones

Based on inlaid marble floor tomb slabs in the nave
of Santa Croce, Florence, Italy. \$15.00
Email: ed@SwampPress.com for more information

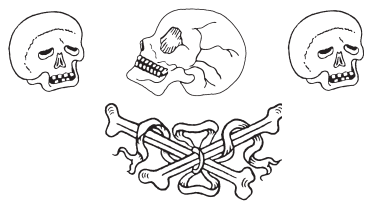

3 each of two skulls, 3 small & 2 large crossbones

24 pt

B R A I L L E
F O R P R I N T I N G

Visual Braille
for printing with ink.

A B C D E F G H I J K
L M N O P Q R S T U V
W X Y Z



TWIST



by *Sonya Clark*

36 point A-Z \$30



“GOLD BOX” Unique Ornaments &etc.

24 pt B R A I L L E

F O R E M B O S S I N G

Embossing Type.
Letter identification
on shoulder of type
does not emboss.



Chocolate Type

24 point Typewriter
Belgian Dark Chocolate

Chocolate Type

- Edible 24 pt Remington Typewriter Type

Cast in dark chocolate. Caps A-Z plus an ampersand.

2 oz, 2 alphabets per package.

Anatomically correct with pin mark, plowed foot & nick !



- Chocolate Linotype Slugs !
- Chocolate display type with jet attached !

Go to SwampPress.com to order or send email...

